

Instruction Manual

Volkswagen Transporter Volkswagen Caravelle



www.vwT25camper.info - a useful website for owners and enthusiasts of VW T25 / T3 / Vanagon Campervans

We thank you for the confidence you have placed in us through the purchase of your new Volkswagen Transporter/Volkswagen Caravelle.

The Volkswagen Transporter/Caravelle is a versatile million-fold proven vehicle. By virtue of its advanced technical design, very careful selection of materials, modern manufacturing techniques and the conscientious efforts of everyone concerned the Volkswagen Transporter/Caravelle also possesses all the virtues typical for Volkswagen such as, economy, quality, reliability and value retention.

For the Volkswagen Transporter/Caravelle the V.A.G Dealers therefore offer

1 Year warranty against defects – with no mileage limit

Thanks to modern technology the Volkswagen Transporter/Caravelle only needs very little maintenance. Normally, an Inspection Service only is required once a year.

It is also reassuring for you to know that one of the largest and most efficient organisations in the world is available to look after your Volkswagen Transporter/Caravelle. In Europe alone there is a network of about 9000 V.A.G Dealerships that work economically and professionally in accordance with factory guidelines.

The V.A.G. Dealers in most European countries also offer a wide range of services and additional warranty cover. For further details, please refer to the notes in your Service Schedule.

*We wish you pleasant and safe motoring at all times,
your VOLKSWAGEN AG*

This Instruction Manual is valid for all Transporter/Caravelle models available ex-factory:

- Caravelle
- Kombi
- Delivery Van
- Dropside Truck
- Double Cab with

- petrol or Diesel engine
- Rear wheel drive and four-wheel-drive (syncro)
- Manual or automatic gearbox.

Certain vehicle models such as, Multivan, Ambulance, special bodies and additional items (e.g. radio) are dealt with in special separate manuals.

The Manual contains important notes on using your car. You should read it carefully, because the correct operation of the vehicle – in addition to regular care and maintenance – serves to maintain its value and is, in many cases, also one of the stipulations for upholding warranty claims.

Special attention should be given to the chapter "Driving tips": These tell you how you can drive **safely, economically and environment consciously**.

For safety reasons please take particular notice of the information on accessories, modifications and the renewal of parts on page 105.

Notes on the layout of this Manual:

In addition to this **Instruction Manual** and any **supplements** which may be required, you will also find the following publications in your vehicle wallet:

The Service Schedule

It contains

- the most important identification data for your vehicle,
- the inspection and oil change intervals,
- the operations which are carried out at the inspection,
- important details about warranty.

In the Service Schedule, service work which has been performed is also confirmed. This could be important if any claims are made under the factory warranty.

You should always present the Service Schedule when you take your vehicle into a V.A.G Dealership.

The list of addresses (V.A.G Service)

This booklet contains

- important information on the V.A.G emergency services
- addresses and telephone numbers of V.A.G Dealerships in Europe and overseas.

If you have any queries regarding the literature supplied please see your V.A.G Dealer.

You can of course also contact our Service Department or the Importer for your country directly. These telephone numbers and addresses are also included in the list.

■ Please note that the items of equipment marked with * are only standard on certain model versions, or only available as optional extras on certain models. Such equipment is not always available in all export markets.

■ **All blocks of text which have this colour backing, and which are headed with the word "Attention" refer to potential accident or injury risks. Please pay particular attention to these warnings.**

■ *Important notes/instructions with regard to environmental protection are printed in italics.*

INSTRUMENT PANEL

Layout 4
Warning lamps 6

OPERATION

Keys, central locking 7, 8
Doors, tailgate 9, 10
Windows, mirrors 11, 12
Seat belts, head restraints 13, 17
Front seats 18
Rear seats 19
Rear seat/Reclining bench 23
Luggage compartment/loading area 24
Folding/sliding cover 24
Pedals, brakes 25
Manual gearbox 27
Differential locks 28
Automatic gearbox 31
Steering/starter lock 33
Starting/stopping engine 34, 36
Warning lamps 37
Instruments 40
Switches 43
Turn signal and headlight dip lever 45
Windscreen wiper 47
Headlight washer system 47
Heating, ventilation 48
Auxiliary heater 51
Air conditioner 57
Sliding/sun roof 58
Interior lights, sun protection 59, 60
Cigarette lighter, ashtray 60
Curtains, table 61
Canopy 62

Dropsides 62
Roof rack/roof railings 62

DRIVING TIPS

Running in and afterwards 63
Driving safely 64
Driving economically and environment consciously 65
Driving with trailer 67
Driving with 4 wheel drive 70

OPERATING INSTRUCTIONS

Refueling, fuel 75, 76
Care for vehicle, maintenance 79, 83
Engine compartment 84
Engine oil, gearbox oil 85, 89
Power assisted steering 90
Cooling system 91
Brake fluid 94
Battery 95
Windscreen wash/wipe system 97
Wheels 99
Arduous operating conditions 103
Winter operation 104
Accessories, modifications, renewal of parts 105

DO-IT-YOURSELF

First aid kit, warning triangle 106
Vehicle tools, vehicle jack 106
Changing wheels 109
Fuses 110

Changing bulbs 112
Adjusting/masking headlights 116
Installing a radio 117
Emergency starting 118
Tow starting/towing 120
Lifting the vehicle 122

TECHNICAL DESCRIPTION

Engine 123
Power transfer 124
Steering, axles 124
Brakes, body 125
Emission control system 126
Petrol vapour accumulator 127

TECHNICAL DATA

Engine data 128
Fuel consumption 129
Performance 132
Climbing ability 133
Spark plugs 134
Vee belts 135
Wheels, tyre pressures 136
Weights, trailer loads 138, 141
Dimensions 142
Capacities 145
Vehicle identification data 146

ALPHABETICAL INDEX 148

INSTRUMENT PANEL

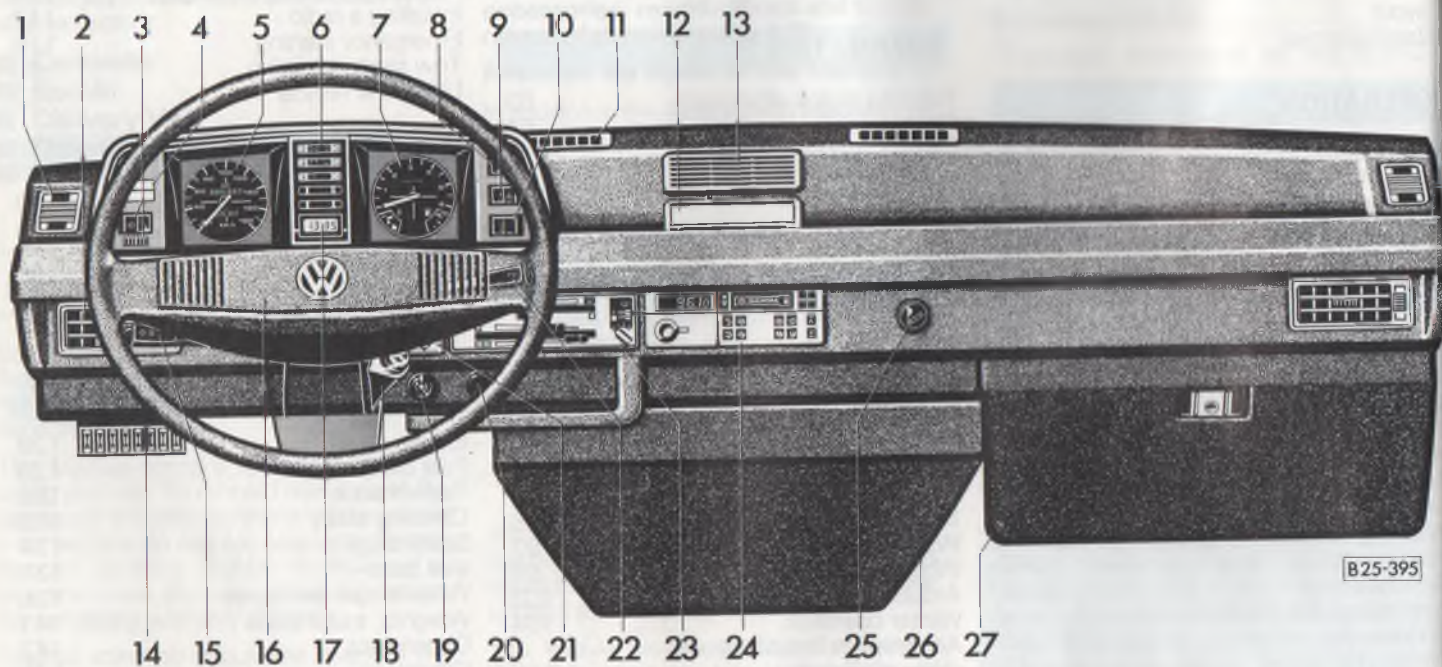

www.vwT25camper.info - a useful website for owners and enthusiasts of VW T25 / T3 / Vanagon Campervans

INSTRUMENT PANEL

	Page		Page		Page
1 – Air vents	48	10 – Fog light/rear fog light switch	44	21 – Blower switch for passenger compartment heat exchanger	50
2 – Air vents	49	11 – Air vents	48	22 – Windscreen wiper/washer lever	47
3 – Light switch and instrument lighting regulator	43	12 – Ashtray	60	23 – Blower switch and levers for ventilation and heating	48
4 – Brake warning light	37	13 – Loudspeaker opening		24 – Radio ¹⁾ or cover plate	
5 – Speedometer	40	14 – Fuse box	110	25 – Socket/cigarette lighter	60
6 – Warning lamps	37	15 – Turn signal and dip switch	45	26 – Air vents	48
7 – Fuel gauge and coolant temperature gauge	41, 42	16 – Horn control		27 – Shelf	61
Clock or rev counter	40, 41	17 – Digital clock	40		
8 – Heated rear window switch	43	18 – Steering lock/starter switch	33		
9 – Emergency light switch	43	19 – Auxiliary heater switch	51		
		20 – Cold starting aid (Diesel engine)	35		

Knobs and warning lamps for the differential locks on Transporter/Caravelle syncro – see page 29.

Note

















Some of the items of equipment listed are only fitted on certain models or are optional extras.

¹⁾ For vehicles with a factory fitted radio, an in-

See remarks on page 117 of "Do-it-yourself" section when service installing a radio.

INSTRUMENT PANEL

WARNING LAMPS

Symbol		Page
	Turn signals	38
	Generator 	38
	Diesel Glow plugs	38
	Engine oil pressure 	39
	Headlight high beams	39
	Coolant temperature/coolant level 	39
	Brake system 	37
	Anti-locking brake system (ABS)	37
	Emergency light system	43
	Rear window heating	43
	Fog lights/rear fog light	44
	Differential locks (syncro)	29

Notes

■ If one of the lamps marked with comes on when driving, stop at once and switch the engine off. Details can be found on the pages given.

■ Some of the lamps shown here are only on certain models or are optional extras. On the other hand there are lamps which are not listed here because they are installed on so few vehicles.

KEYS

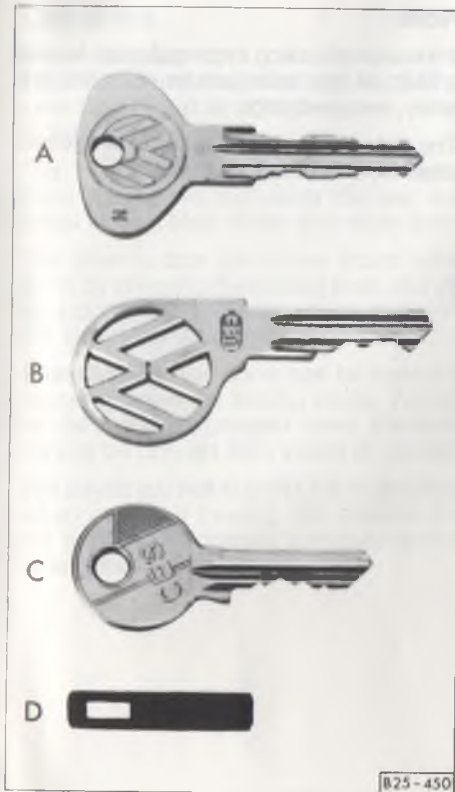

Up to six keys are supplied with the vehicle:

- two keys A
- two keys B*
- two keys C*

Key A

This key fits all locks except:

- lockable glove box
- sliding door and rear flap with safety locks

Attention

When leaving the vehicle unattended – even only for a few moments – always take the ignition key with you.

Key B

This key fits the lockable glove box*

Key C

This key fits the safety locks in sliding door and tailgate.

It can only be withdrawn when the sliding door or tailgate is locked.

Tag D

On this tag is the number for key A. The tag should be kept safely and separately (in your wallet for example) so that no unauthorized person can order a key. The numbers of keys B and C are stamped on the keys.

With the aid of the number, a replacement key can be ordered from a V.A.G Dealership.

In addition to the plastic tag there may also be a metal tag on which there is a part of the vehicle identification number. This tag is no longer required after vehicle has been delivered.

Note

On four-wheel drive vehicles there is an extra key for the lockable tank cap.

OPERATION

CENTRAL LOCKING SYSTEM*

With this system all the doors, and – depending on the position of the tailgate lock – also the tailgate can be locked and unlocked.

The system is operated from the **driver's door**, and front passenger door – from outside with the key, from inside with the locking knob.

Note

The central locking system can only function correctly when the driver's and front passenger doors are properly closed.

When locking, the locking knobs on all doors must move down. If the knob on one door does not move at any time, open the door concerned and close it properly.

Attention

When the locking knobs in the driver's and front passenger doors are pressed down all the doors are locked. Children should therefore not be left on their own in the vehicle, because when the doors are locked it would be difficult to help in an emergency.

Sliding door and tailgate can be locked or unlocked separately with the key.

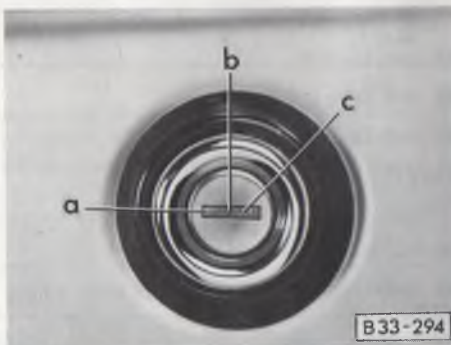

To unlock the tailgate insert key and turn it to right (c). Hold in this position and press button in.

If the key is withdrawn in the horizontal position (a), locking of the tailgate will be controlled by the central locking system when it is closed again.

When the key is withdrawn in the vertical position (b) and tailgate closed, it will be locked all the time. The tailgate can then only be unlocked with the key.

Note

If the central locking system should develop a fault, all the locks can be operated normally, see next page.

The sliding door can be secured or released separately with the safety catch.

DOORS

Cab doors

From outside both cab doors can be locked and unlocked with the key. When unlocking the locking knobs go up, when locking they go down.

The front passenger door can be locked from outside without using the key: Just press locking knob down and close door.

The driver's door cannot be locked when open by pressing the locking knob and closing door. This prevents you from leaving the key in the vehicle and forgetting it.

From inside, the doors can be locked by pressing down the locking knobs. As long as the knobs are pressed down, the doors cannot be opened from inside or outside.

We advise you **not** to press the knobs down when vehicle is moving, this ensures that the door can be opened from outside in an emergency.

Sliding door

From outside, the sliding door can be locked and unlocked with the key. When fully open the door is held by a hook.

To close sliding door from outside – press the door handle down to release the hook and slide the door firmly forwards.

The sliding door can also be locked from outside without using the key: Press locking catch in and close door.

From inside, the sliding door is locked by pushing down the locking catch near the door opening lever.

As long as the catch is in the lower position the door cannot be opened from inside or outside.

When the vehicle is moving, the door must always be properly closed, but when carrying passengers the locking catch should be left in the upper position so that the door can be opened from outside in an emergency.

Child-proof catch on sliding door*

When the child-proof catch is engaged – lever on door lock turned upwards – the inner lock release lever is inoperative. The door can only be opened from outside with the locking catch in the up position.

OPERATION

TAILGATE

To **open** the tailgate when key slot is horizontal, press the lock cylinder and lift tailgate.

Note

The lock cylinder can also be pressed in with the key.

To close tailgate pull it down and slam it to gently.

Attention

After closing the tailgate always pull up on it to make sure that it is properly closed – otherwise the tailgate could open suddenly when vehicle is moving even though the key has been turned in the lock.

Do not drive with the tailgate open as exhaust gases are then able to enter the vehicle interior.

Opening from inside*

On vehicles with a full-width partition behind the cab and seats in rear compartment, the tailgate can be opened from inside in an emergency. To do this the cap must be taken off the lock in tailgate. Then press release lever to the right and open tailgate.

WINDOWS

**Vent wings***

To open – Press button in fastener and swing fastener forwards.

To close – Press window against seal at front and turn fastener to the rear until button engages.

**Sliding windows***

To open, press catch down and slide window along.

Door windows

These windows are opened and closed with the crank in the door trim.

**Electrical control***

When the ignition is switched on, the windows can be opened and closed electrically.

The switch is in the door trim.

The window in the passenger door can be controlled from the driver's side.

- a – Driver's door
- b – Passenger's door

Attention

Careless and uncontrolled closing of the windows can cause injuries. Take care therefore when closing the windows. When leaving the vehicle always take the keys with you.

OPERATION

MIRRORS

The rear view mirror should always be adjusted properly before moving off to ensure good vision to the rear.

Note for vehicles with convex outside mirror*

Convex (curved outwards) mirrors enlarge the field of view but they make objects look smaller. These mirrors make it difficult to estimate how far the vehicle behind is away.

Adjusting mirrors

Normal outside mirrors are adjusted by moving the mirror housing.

The outside mirror should be adjusted so that the side of your own vehicle can just be seen. This setting ensures the best possible field of view, and in addition it serves as an instant check on the mirror setting.

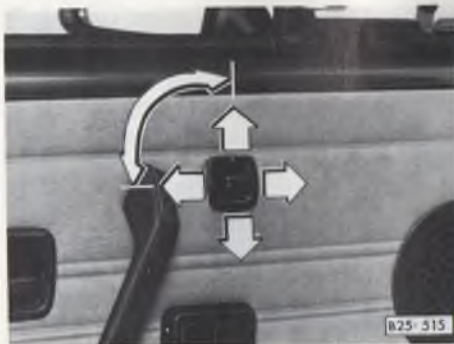

Electrically adjustable mirrors*

are set by moving the lever in the driver's door trim.

Turning the knob from L to R switches control from left to right mirror.

If the electrical control of the mirror fails at any time the mirrors can be adjusted by hand by pressing on the edge of the mirror surface.

Mirror heating

The electrically operated outside mirrors are heated when the heated rear window is switched on.



Anti-dazzle interior mirror*

The lever on the lower edge of the mirror must be pointing forwards when the basic setting is made.

For anti-dazzle setting pull the lever to the rear.

SEAT BELTS

It has been proven that seat belts give good protection in accidents. In most countries therefore the wearing of seat belts is required by law.

Attention

The belts should be put on before every journey – even in town traffic.

All vehicles occupants should always wear the seat belts – including those on the rear seats.

Even pregnant women should always wear a seat belt.

The routing of the belt is of major importance to the protective effect of the belt.

How the belt should be worn is described on the following pages.

Safety for children

Children under 12 years of age should normally travel on the rear seat (Carrera, Combi, Double cab). Depending upon their ages, height and weight, they must be protected with either a child restraint system or the seat belts provided.

A child may also occupy the front passenger seat if the restraint system used has been expressly approved for this purpose by the manufacturer. One should bear in mind however that they are generally safer on the rear seat.

On no account should babies or small children travel on an adult's lap.

■ Babies up to about 9 months old/10 kg are best protected, in an accident, with a safety seat or a special safety carrier.

■ Children up to about 7 years of age/25 kg, depending on their height, are safest when secured in a child seat or by a safety seat cushion.

■ Children over about 7 years of age may use the three point belts or the two point belts provided. It is important to ensure that the diagonal part of the belt fits over the centre of the shoulder – **and does not make contact with the neck.** The lap part of the belt must pass across the pelvis **and not over the child's stomach.**

If necessary a safety cushion should be used to raise the seating position.

Note the following points when purchasing, installing and using a child restraint system:

■ For safety reasons always use a restraint system which conforms to the international safety standard ECE R 44. Restraint systems that can be connected to the seat belts provided in the car are recommended. If the existing belts are too short, one can use adapter belts which are available from V.A.G Dealerships.

■ Experience has shown that babies and small children are best protected in child seats or safety carriers where they can lie or sit facing the rear of the vehicle.

■ Only use child seats or safety carriers of the type which have a large, flat area in contact with the car's seat upholstery. Child seats which have feet or tubular frames and no flat base can easily penetrate into the car's upholstery, and are therefore not so safe.

■ Special care must be taken if child restraint systems are used which are secured at the same point as the belts provided in the vehicle. One must ensure that the full thread length of the securing bolts is screwed into the threaded holes.

Furthermore, one should ensure that the belt itself cannot become damaged by sharp edged buckles etc.

■ **For the installation and use, attention must be paid to the legal regulations and the instructions of the restraint system manufacturer.**

General notes

The belt must not be twisted.

Two persons (including children) must never be secured with one belt. It is particularly dangerous to put the belt round a child sitting on a person's lap.

On vehicles with armrests on the seats*, one must always ensure that the lap belt is routed underneath the armrest.

The belt should not be worn over hard or breakable articles (glasses, ball pens, key rings, pipes, etc.) because this can cause injury to the body.

Loose, bulky clothing (e.g. overcoats over jackets) affects the fit and function of the belts.

The belt must not be jammed anywhere or rub on any sharp edges.

The lock tongue may only be inserted into the lock part belonging to the appropriate seat otherwise, the protective effect is impaired.

The slot for the belt tongue must not be blocked with paper or anything similar, otherwise the tongue cannot engage properly.

The belts must be kept clean otherwise the retractors may not work properly (see also "Care of car" section).

Seat belts which have become damaged or have been stressed in an accident and stretched must be renewed – preferably by a V.A.G. Dealership. The anchorages should also be checked.

Note:

On the Delivery Van there are no belt anchorage points in the load compartment.

In some export countries seat belts could be used on which the functions differ from those mentioned on the following pages.

Three-point inertia reel belts

The inertia reel belt gives complete freedom of movement when pulled slowly. Sudden braking however will cause the belt to lock.

The automatic retractor mechanism will also lock the belt when accelerating, driving down steep gradients or cornering.



Putting the belt on

Pull the tongue slowly and smoothly across your chest and hips and push it into the lock part fitted on the seat until tongue engages audibly (pull to check).

The shoulder part of the belt must run roughly across the centre of the shoulder as shown – on no account against the neck – and be firmly in contact with the body.

On the front seats the shoulder belts can be made to fit properly by using a belt height adapter*.

The lap part of belt must always fit tightly across the pelvis. Pull belt tight if necessary.

Particularly in the case of pregnant women the lap part of the belt should be as low across the pelvis as possible to ensure that no pressure is exerted on the abdomen.

The backrests of the front seats must not be inclined too far to the rear otherwise the belts are not longer effective.

Taking the belt off

To release the belt, press the orange-coloured button in the lock. The tongue will then spring out.

Pass the tongue towards the door by hand so that the retractor can roll the belt up properly.

OPERATION

Three point automatic belts for seat/reclining bench*

Attention

On vehicles which have a seat/reclining bench and three point automatic belts, special attention must be paid to ensure that the belt does not become jammed and damaged, when the seat/bench is folded down, or when it is put up again.

For this reason therefore, the belt tongue must be hung up on a hook provided on the side wall between the windows. If the vehicle is equipped with a centre seat bench the hook is hidden by centre seat bench belt.

Belt height adjustment

Two anchorage points are provided in the cab for the upper belt attachment. This makes it possible to adapt belt to body size.



Lap belt*

The buckle is used in the same way as on the three-point inertia reel belts.

The belt must always fit tightly across the pelvis.

To lengthen belt hold the tongue at right angles to belt and pull belt through to the required length – see illustration.

The belt is easier to adjust if tongue and cap are pressed together.

To shorten belt it is only necessary to pull the free end of belt.

The surplus belt length is taken up by moving the plastic slide.

Two-point inertia reel belts*

The individual seats* in the passenger compartment are fitted with two-point inertia reel belts. They give complete freedom of movement when pulled slowly but sudden braking however will cause the belts to lock. The automatic retractor mechanism will also lock the belt when driving down steep gradients or coming hard.

Putting belt on

Pull the tongue slowly and smoothly across the hips and push it into the lock part fitted on the seat until tongue engages audibly (pull to check).

The belt must not be twisted. The belt must always fit tightly, pull belt up slightly if necessary.

Taking belt off

To release the belt press the orange-coloured button in the lock. The tongue will then spring out.

Pass the tongue across by hand so that the retractor can roll the belt up properly.

HEAD RESTRAINTS*

**Attention**

The head restraints must be adjusted properly to suit the body size. Only correctly adjusted head restraints, together with the seat belts, provide effective protection.

**Adjusting height**

Grip at sides with both hands and pull up or push down. The upper edge should be roughly at eye level.

Removing and installing

Push spring clips out of slotted rings in backrest with a small screwdriver and lift head restraint out.

To install, first press the spring clips into the guide rings so that the straight part of clip is at the rear. Then push head restraint rods into the guides until they engage audibly.

Note:

The spring clips need not to be taken out on vehicles which have a rear seat/fully reclining seat bench*.

It is quite sufficient to push the protruding spring clip extensions back to the rear, to enable the head restraints to be removed.

OPERATION

SEATS IN CAB



Separate driver and front passenger seats

To move seats backwards or forwards

Lift lever (1) on outside of seat and move seat. Then release lever and move seat further so that catch engages.

Attention

- For safety reasons the seats should only be adjusted when vehicle is stationary.

To adjust backrest rake

Take weight off backrest, press lever (2) on right side of seat frame down and move backrest to desired position by moving upper part of body, then release lever.



Attention

- Do not lower the backrest too far when on the move because the seat belts are then no longer fully effective.

Armrests*

The armrests on the front seats can be hinged up if they are not required.

The angle of the armrests can be adjusted as required with a knurled knob, underneath the armrest.

To take seat out

- Slide seat forward into 1st latch position.
- Lift hook (3) against spring pressure and at the same time pull lever (1), hold it and slide seat past stop.
- Release hook and lever and push seat forward out of runners.
- The hook need not be lifted when putting seat back as the seat, with the lever lifted, can just be pushed past the stop.

Seat heating*

Seat cushion and backrest of driver's seat can be heated electrically when ignition is on.

Further details are given under "Switches", page 44.

Head restraints*

The head restraints must be adjusted to body size – see page 17.

SEATS IN PASSENGER COMPARTMENT*

Two seater bench*

The seat is moved backwards or forwards in same way as the single seats. The lever is at the front of seat. When seat is moved, the backrest rake is also altered.

To remove

Remove in same way as the single seats. Bolts on right and left of backrest must also be removed.

Swivelling seats*

On vehicles with swivelling seats the passenger's seat can be turned 180° to the right and the driver's seat 90° to the left. To turn seats, push them forward slightly or open door, and pull the release lever.

Attention

The handbrake must be released before turning driver's seat. (Engage a gear to prevent vehicle from rolling away.)

The swivelling seats must always be facing forward when vehicle is moving.

Removing and installing centre seat bench

The centre seat is pushed into two runners and secured with four screws. To take the seat out, the floor covering must be lifted and the screws removed. The seat can then be pulled out of the runners sideways through the opened sliding door.

Note

On vehicles with floor carpeting, the securing strip in the sill area must be taken off first and the carpet then lifted carefully. Take care when doing this to ensure that the carpet does not tear at the cut-outs.

When reinstalling the seat bench, ensure that the retaining rails are clean.

Removing and installing rear bench seat

The rear seat cushion is bolted to the side panels on each side with one bolt under the upholstery. Remove bolts and take lower part of seat out.

The seat backrest is secured at each side with two bolts. The bolts between seats and backrest also serve as seat belt anchorages.

When refitting the seat and backrest, ensure that the seat belt is also correctly installed.

OPERATION

INDIVIDUAL SEATS IN PASSENGER COMPARTMENT*

Centre seats

The centre seats can be turned and the backrest angle adjusted.



Turning

Lift lever (see illustration), turn seat to the desired position and let lever engage again.

If the backrest is very low, it may be necessary to raise it slightly before the seat can be turned.



Adjusting backrest angle

Take weight off backrest and press lever down (see illustration). Adjust backrest to the desired position by moving upper part of body and release lever.

Removing

Lift the lever used to turn seat and take seat out.

The base which remains can be removed when carpet is lifted.

Attention

When the seats are installed again, ensure that base and seats are secured properly.

Rear seats

The height, seat angle and backrest angle of the rear seats can be adjusted.

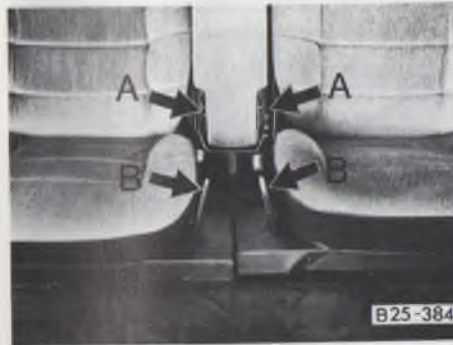

Mechanical adjustment

Adjusting seat angle

Press lever B to front or rear and adjust position of seat as required, by moving body weight.

Adjusting seat height

Press lever B alternately at front and rear and by moving weight of body to front and rear, lift or lower the seat.

Adjusting backrest angle

Take weight off backrest and turn knob A at side of backrest.

Attention

When vehicle is moving, the backrests must not be inclined too far to the rear, otherwise the belts are no longer fully effective.

OPERATION

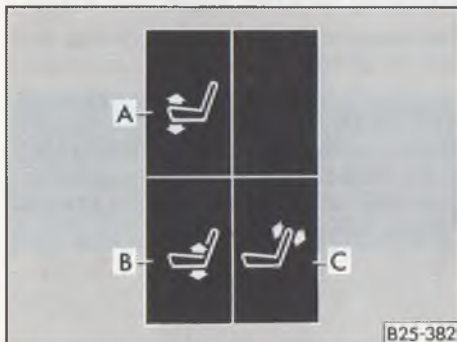

Electrical adjustment*

Adjusting seat angle

Press switch A at front – front of seat is raised.
Press switch A at rear – front of seat is lowered.

Press switch B at front – seat is raised at rear.
Press switch B at rear – seat is lowered at rear.

Adjusting seat height

Press switches A and B at front – seat is raised.
Press switches A and B at rear – seat is lowered.

Adjusting backrest angle

Press switch C at front – backrest moves up.
Press switch C at rear – backrest moves down.

Attention

When vehicle is moving, the backrests should not be inclined too far to the rear, otherwise the seat belts are no longer fully effective.

REAR SEAT/ FULLY RECLINING SEAT BENCH*



The rear seat/reclining seat bench can be converted into a large sleeping area.

Before doing this, the backrests of the center row of seats must be tipped forward. The latching levers are located on the outside of the right and left hand backrests.

To convert reclining seat bench

- Remove head restraints* – see page 17.
- Unlatch the backrest with the release grip on the reverse side of the backrest, and fold the backrest forward.



- By pulling the release grip further towards the front, the backrest and seat bench are tipped forward.
- Finally, fold the seat backrest fully to the rear to form a flat sleeping area.

Returning seat bench to original position

- Pull the seat backrest upwards out of the horizontal position.
- Slide the seat bench, together with backrest to the rear again.
- Push backrest back into locking position.

Attention

The rear seat backrest must be properly engaged to ensure that nothing can slide forward out of the luggage compartment when the brakes are applied suddenly.



- Pull the seat belts out again between backrest and seat, so that they are once again ready for use.
- Install head restraints* – see page 17.

The space underneath the seat bench can be used as a storage compartment. For this, it is necessary to lift the seat bench slightly at the front. It will remain in the lifted position when the strut, located on the left on the sliding door side, is swung upwards.

Three point automatic belts for seat/reclining bench*

Attention

On vehicles which have a seat/reclining bench and three point automatic belts, special attention must be paid to ensure that the belt does not become jammed and damaged, when the seat/bench is folded down, or when it is put up again.

For this reason therefore, the belt tongue must be hung up on a hook provided on the side wall between the windows. If the vehicle is equipped with a centre seat bench the hook is hidden by centre seat bench belt.

OPERATION

LUGGAGE COMPARTMENT/ LOAD SURFACE

To enlarge luggage space*

- Release backrest by pulling loop
- Fold backrest down onto seat

The backrest locks automatically when hinged to the rear.

Attention

The rear seat backrest must be properly engaged to ensure that nothing can slide forward out of the luggage compartment when the brakes are applied suddenly.

Instructions on using the rear/reclining seat* are given on page 24.

Notes on loading

- The load must be stowed so that it cannot slip or even fly forward when the brakes are applied.
- In the interests of good handling the load should, wherever possible, be carried between the axles. The permissible axle loads and the permissible gross vehicle weight may on no account be exceeded.
- Ensure that the heater element in the rear window is not damaged by articles rubbing against it.

Attention

Never drive with the luggage compartment not properly closed otherwise exhaust gas can be drawn into the vehicle interior.

LUGGAGE COMPARTMENT FOLDING COVER*

The folding cover can be pushed together to the front or rear, or taken out altogether.

When the front part is to be pushed to the rear, or the rear part to the front, the appropriate rod must be jerked out of the retainers. When the rear rod is pushed fully forward it engages.

Attention

No heavy or hard articles may be placed on the folding cover, otherwise they will not only be a danger to the vehicle occupants if the vehicle is braked suddenly, but they could also damage the cover itself.

Ensure that:

- The cover is correctly located in its mountings when vehicle is moving.
- No items of luggage can fly forward if brakes are applied sharply.
- The heater element in the rear window is not damaged by articles rubbing against it.
- Vision through rear window is not obstructed, otherwise a second outside mirror must be fitted.

PEDALS

The movement of the pedals must never be restricted.

For this reason, do not put articles in the footwell which could roll or slide underneath the pedals.

Around the pedal area there should be no foot mats or other additional floor covering materials:

- In the case of brake system defects a greater pedal travel may be necessary.
- It should always be possible to depress the clutch and accelerator pedals fully.
- All pedals must be able to return, unhindered, to their rest positions.

For these reasons therefore, the only foot mats which may be used, are those which leave the pedal area completely free and which are prevented from slipping.

BRAKE SYSTEM

The following points are of particular importance to the safe operation of the brakes.

- New brake linings must also be run in and do not have the optimum friction properties during the first 200 km. The slightly reduced braking effect can be compensated for by slightly more pressure on the brake pedal. This also applies when new linings have been fitted.
- If the brake pedal travel increases suddenly, it may be that one of the two brake circuits has failed. You can still drive on to the next V.A.G Dealership but be prepared to use more pressure on the pedal and allow for longer braking distances on the way.
- The brake fluid level must be checked regularly – see page 94.

Failure of a brake circuit is indicated by the brake warning lamp* lighting up (see also page 37).

- Brake lining wear depends to a large extent on the operating conditions and style of driving. Particularly on vehicles which are used mainly in town traffic and stop/start conditions or are driven hard it may be necessary to have the thickness of the brake linings checked in a V.A.G Dealership in between the intervals given in the Service Schedule.

- When driving downhill change down in good time to make use of the braking effect of engine. This relieves strain on the brake system. When brakes are applied do not keep them on continuously, apply and release alternately.

- In certain operating conditions, for example after driving through water, after heavy rain or after washing the vehicle, the braking effect may be retarded by wet, or in winter iced-up brake discs and linings – the brakes must be dried out by applying the footbrake.

The full braking force may also be retarded when vehicle has been driven for some time on heavily salted roads without using the brakes because the layer of salt on discs and pads has to be removed first.

Further details – particularly for vehicles with four wheel drive – are given on page 70.

OPERATION

Attention

If a front spoiler is retrofitted, one must ensure that the air flow to the front brakes is not impeded, otherwise the brake system could overheat.

V.A.G Dealerships are informed as to the existing technical possibilities.

Brake servo

The servo is operated by vacuum which is only available when engine is running.

Attention

For this reason the vehicle should not be allowed to roll with the engine switched off.

When the brake servo is not working because, for example, the vehicle is being towed, or because a defect has occurred on the brake servo, the brake pedal must be pressed harder.

Anti-locking Brake System*

The ABS plays a major part in increasing the active safety of the vehicle. The big advantage of the ABS compared with the conventional braking system is that even when braking on slippery surfaces the wheels do not lock. The vehicle remains steerable and the best possible driving stability is retained.

When the turning speed of a wheel reaches a level which is too low for the vehicle speed and it tends to lock, the brake pressure to this wheel is reduced. This regulating process is felt as a pulsation of the brake pedal and is accompanied by noise. This is deliberately done as a warning to the driver that the wheels are in the locking range. **The speed must immediately be adapted to the road and traffic conditions.**

Attention

Particularly on slippery roads the ABS cannot overcome the physical limits. The increased amount of safety available must not tempt one into taking any risks when driving.

Every time the engine is started the ABS is switched on automatically.

If a defect occurs in the ABS it is indicated by a warning lamp – see page 38.

Note

On 4 wheel drive vehicles the ABS function is negatively affected when a differential lock is engaged. For this reason, a warning buzzer sounds at speeds above 50 km/h as a reminder that the rear axle differential lock is engaged, and that it must be disengaged.

Handbrake

The handbrake is located between the front seats.

To apply the handbrake, pull lever up firmly. On hilly roads the 1st gear, or on automatic gearboxes the parking lock, should also be engaged. The handbrake should always be applied so firmly that it is not possible to drive off accidentally with handbrake slightly on.

When handbrake is applied with the ignition on, the brake warning lamp* comes on.

To release handbrake, pull lever up slightly, press locking knob in and push lever right down.

MANUAL GEARBOX

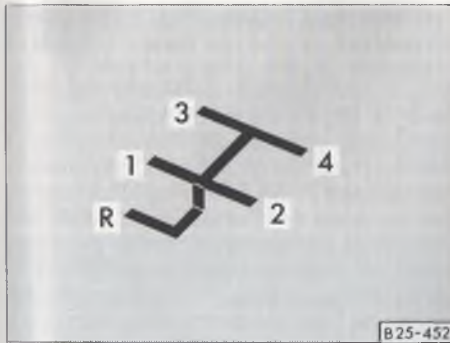

4 speed gearbox

Engaging reverse

Move lever in neutral to the left, press it down and move it further to the left stop and then push it forward.

Only engage reverse gear when vehicle is stationary.

When engine is running, depress clutch fully and wait a few seconds before moving gear lever, to prevent grating noises.

When reverse gear is engaged with ignition on, the reversing lights* come on.

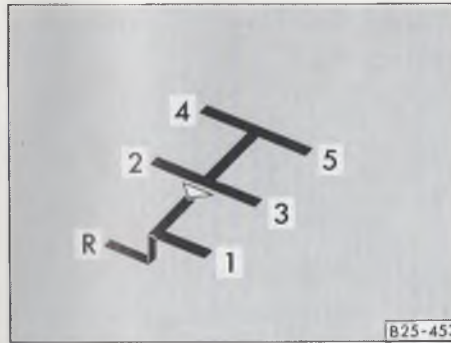

5 speed gearbox*

To engage 1st gear move lever past pressure point to left stop and then pull it back.

To engage reverse gear move lever past pressure point to left stop, press it down and push it forwards.

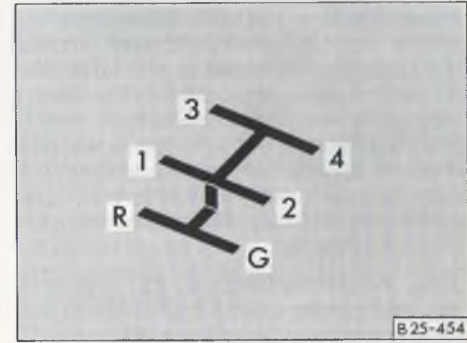

4+G gearbox (syncro)

Engaging crawler gear (G) on syncro

Move lever in neutral to the left, press it down and move it further to the left stop and then pull it to the rear.

Note

When driving, do not rest your hand on the gear lever. The pressure is transmitted to the shift forks in the gearbox and can cause premature wear.

OPERATION

DIFFERENTIAL LOCKS*

When negotiating a curve, the wheels of a vehicle cover different distances. To balance out the differences in wheel speeds, differentials are incorporated in the driving axles. However, these differentials have a distinct characteristic: As soon as one wheel on an axle commences to spin on a slippery surface, only very little traction is available, even though the other wheel is on a hard surface.

Using the differential locks, the wheels of one axle can be locked together and the traction is once again obtained.

On the Transporter/Caravelle there are two different types of differential lock: Vehicles with rear wheel drive have a limited slip differential in the rear axle and 4 WD vehicles (syncro) have selectable mechanical locks in front and rear differentials.

Limited slip differential*

(Rear wheel drive)

The locking effect is obtained by means of plates which are arranged in the differential as a sort of multi-plate clutch. With this differential the locking effect is not 100 % but only approx. 45 %. Contrary to vehicles with 100 % locking, the steering behaviour on the road, particularly in sharp curves, remains almost unchanged.

The effective locking force is dependent on the speed difference of the two driving wheels. This means: the greater the difference, the greater is the locking force of the differential.

Driving tips

Under normal conditions, the vehicle can be driven just like every other vehicle. At the beginning it may take a bit of getting used to when driving through sharp bends. This is due to the fact that a slight locking effect is always present.

Furthermore in isolated borderline conditions where, on the one hand the frictional resistance of the driving wheels on the ground differs a great deal and, on the other hand, a large amount of power must be transmitted to move off, it may be found that the maximum possible locking effect is not obtained in the differential. One notices this because one wheel spins while the other does not turn at all. In this case one should engage and disengage the clutch gently and repeatedly. This will prevent the differential from becoming overheated.

Gear oil

The oil level does not need checking between the intervals prescribed in the Service Schedule. Neither does the oil need changing. To top up or fill after a repair, a V.A.G Dealership should be contacted, because the gearbox must be filled with a special oil.

Selectable differential locks*

(syncro)

With the selectable differential locks, the wheels on one axle are fully locked together (100 %). As no compensation takes place when cornering, the handling and steerability are affected – particularly in the case of the front differential lock.

Attention

The differential locks may only be used under the limited specific conditions described on the following pages.

**Engaging the differential locks**

The differential locks are engaged and disengaged with the knobs shown in the centre of the instrument panel, either while the vehicle is stationary or moving.

Left knob – Front axle differential lock

The knob for the front differential lock is secured so that it cannot be pulled unintentionally. The knob must therefore be turned to the right before it is pulled out.

Right knob – Rear axle differential lock

When the knobs are pulled/pushed engagement or disengagement is only selected. The actual shifting process can be delayed. If the wheels are rotating at different speeds, or if the drive train is under strain, e.g. tight corner, it could even happen that the lock will not engage or disengage at all. In such a case, throttle application should be reduced and the vehicle should be driven straight-ahead while moving steering wheel slightly to enable the lock to engage/disengage.

The warning lamps above the knobs indicate the operational condition of the locks:

- If the front axle differential lock has been selected, the left hand warning lamp flashes. As soon as the lock engages the lamp lights up continuously.
- The right hand warning lamp monitors the function of the rear axle differential lock. It does not flash when the lock has been selected but only lights up once the lock has engaged properly.

On vehicles with ABS a warning buzzer sounds, as an additional warning, at speeds above 50 km/h as a reminder that the rear axle differential lock is still engaged. Further information is given on page 26.

OPERATION

■ Both warning lamps go out again once the knobs have been pushed in and the locks have actually disengaged.

If after selecting the differential locks, and after driving some distance, the warning lamps do not light up, the electrical system and the locks themselves should be checked at a V.A.G Dealership.

Attention

The differential locks influence the steerability of the vehicle. In particular, with the front axle differential lock engaged, the vehicle is no longer steerable. For this reason, the front axle differential lock must only be used under off-road conditions and then only at low speeds. Always disengage the lock before driving on metalled road surfaces.

When may the differential locks not be engaged?

■ Neither the front nor the rear axle differential locks may be engaged when driving along metalled road surfaces.

Locking the front axle differential makes the vehicle unsteerable.

When the rear axle differential is locked, the rigid connection between the two rear wheels has a scrubbing effect on the tyres when cornering. This leads to increased tyre wear and also to "jerking" when the vehicle is being steered. In certain circumstances it may even damage the drive train.

For this reason, the locks may only be engaged under off-road conditions or as an assistance when moving off.

See "Driving Tips" on page 72 also.

■ When a wheel is spinning if, for example, the vehicle is stuck in snow, this would not only lead to increased tyre wear but it could also damage the drive train and lead to uncontrollable acceleration. For this reason, the spinning wheel must first be brought to a standstill before the differential locks are engaged.

■ When the vehicle is being towed – see page 120 also.

■ When testing the vehicle on a dynamometer, e.g. when being tested by local authorities – see page 74 also.

AUTOMATIC GEARBOX

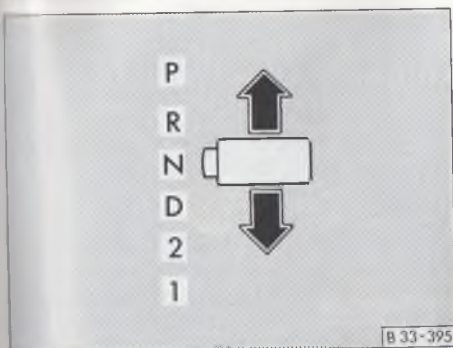

Selector lever positions

P – Parking lock

The driving wheels are locked mechanically.

The parking lock may only be engaged when vehicle is standing still. To move lever into and out of the "P" position the safety catch in the lever handle must be pressed.

Depending on the vehicle version an additional electric selector lever lock could be fitted. Then, the selector lever can only be moved out of position "P" if the **brake pedal** is depressed and the safety catch on the selector lever is pressed as well.

R – Reverse gear

The reverse gear may only be engaged when vehicle is stationary and with the engine idling. Before "R" can be engaged the safety catch in the lever handle must be pressed.

N – Neutral

Depending on the vehicle version, an additional electric selector lever lock could be fitted. Then, the selector lever can only be moved out of position "N" at speeds below 5 km/h or when the vehicle is stationary, if the **brake pedal** is depressed and the selector lever safety catch is pressed at the same time.

D – Normal driving position

The three forward gears are shifted up and down automatically according to throttle opening and road speed.

2 – Position for hilly stretches

The 1st and 2nd gears are shifted up and down automatically according to throttle opening and road speed. The 3rd gear is not used. This increases the engine braking effect.

The road speed must not exceed 90 km/h (56 mph).

The lever can be moved from "D" into "2" with accelerator pedal depressed. However, as the shift into 2nd gear takes place immediately this must **only be done at speeds below 85 km/h**.

1 – Position for steep hills

To engage this gear, the catch in the lever handle must be pressed. The vehicle remains in 1st gear, and 2nd and 3rd gears are not used. This gives maximum possible engine braking effect. The road speed must not exceed 50 km/h (30 mph).

The lever can be moved from "2" into "1" with accelerator pedal depressed. However, as the shift into 1st gear takes place immediately this must **only be done at speeds below 45 km/h**.

Kick-down device

The kick-down device gives maximum acceleration. When the accelerator pedal is pressed right down past the full throttle position, depending on road speed and engine speed, either the upshift is delayed (forced throttle) or the box changes down into the next lower gear.

OPERATION

Notes on driving

Starting

The engine can only be started when selector lever is at "N" or "P". See "Starting engine" on page 34 also.

Selecting a driving range

Attention

Before selecting a gear with vehicle stationary and engine running, always depress the footbrake. This also applies when moving lever from "P" to "N".

Particularly when the idling speed is high (after starting from cold) it is necessary to hold the vehicle with the brake.

This is necessary because with an automatic gearbox the transfer of power is not completely interrupted even at idling speed – the vehicle tends to "creep".

When selecting a gear with vehicle stationary, do not depress accelerator.

When a driving range is selected with the vehicle stationary, the throttle must on no account be opened (e.g. by hand from engine compartment), because the vehicle will move immediately – possibly even with the handbrake applied.

Before working on the engine when it is running, place selector lever at "P" and apply handbrake.

If the lever is moved accidentally into "N" when driving, release accelerator and let the engine speed drop to idling before selecting a forward gear again.

Driving downhill in winter

Before driving down a long slippery gradient after starting from cold in a vehicle with a carburetor engine, ensure that engine is warmed up enough to idle at normal speed. Otherwise the engine braking effect will be limited when accelerator pedal is released and gentle braking on the slippery surface will not be possible.

Stopping

To stop vehicle temporarily such as at traffic lights, all that is necessary is to apply the brakes. It is not necessary to move lever to „N“. The engine should however only be running at idling speed.

Parking

On level ground it is sufficient to apply the handbrake. On a gradient the handbrake should be applied firmly first, and then the parking lock engaged. This will ensure that the locking mechanism is not too heavily loaded and makes the lock easier to disengage.

Tow starting

On vehicles with an automatic gearbox the engine cannot be started by towing or pushing the vehicle.

When the battery is flat, the engine can be started from the battery of another vehicle, using jumper cables. See "Emergency starting", page 118.

Towing

If the vehicle has to be towed at any time, you must read the instructions in the section "Towing" on page 120.

STEERING LOCK/IGNITION SWITCH

**Petrol engine**

- 1 – Ignition off – Steering can be locked
- 2 – Ignition on
- 3 – Starting engine

Diesel engine

- 1 – Fuel supply cut off – Steering can be locked
- 2 – **Glow and drive position**
While glow plugs are on, no other heavy current consumers should be switched on.
- 3 – **Starting engine**

For all vehicles:**Position 1:**

To **lock the steering**, withdraw the key and turn the wheel until you hear the pin engage.

Attention

Do not withdraw key until vehicle is stationary.

Position 2:

If the key is difficult to turn in the lock, or cannot be turned to this position at all, the steering wheel must be rocked to and fro slightly to release the locking pin.

Position 3:

In this position, the headlights and other heavy electrical current consumers are switched off.

Before the starter can be operated again the key must be turned back to position 1. The non-repeat lock in the ignition switch prevents the starter from being operated when engine is running, as this could damage the starter.

OPERATION

STARTING THE ENGINE

General notes

Attention

■ **When starting the engine in a confined space as there is a danger of poisoning.**

■ Before starting the engine, check that the gear lever is in neutral. (On vehicles with automatic gearbox: Selector lever at "P" or "N") and apply handbrake firmly.

■ Depress the clutch pedal on vehicles with manual gearbox when starting, so that the starter only has to turn the engine.

■ As soon as the engine starts, release the ignition key, so that the starter can disengage.

■ After starting a cold engine it may sound noisy for a few moments because the oil pressure has to build up in the hydraulic tappets* first. This is normal and no cause for alarm.

■ *Do not warm engine up by running it with vehicle stationary. Drive off straight away.*

■ Do not overrev or use full throttle until the engine has reached the normal operating temperature.

■ **On vehicles with a catalytic converter the engine must not be started when catalytic converter is at operating temperature, by towing the vehicle a long distance, otherwise unburnt fuel can pass into the catalytic converter and be burned there.**

44 and 57 kW carburetor engines Starting a cold engine

The carburetor is fitted with an automatic choke which is actuated the first time the accelerator pedal is depressed, when engine is cold.

■ Depress accelerator pedal slowly **once (twice when it is freezing)** and then release it.

■ Start engine – **do not use accelerator.**

■ If the engine does not start at once, stop using starter after 10 seconds, wait about half a minute and then try again.

■ The increase in the idling speed which takes place as engine starts to warm up can be reduced by tapping the accelerator pedal briefly.

On vehicles with an automatic gearbox the engine should be run at fast idling speed for about one minute after starting when it is very cold.

The pedal should then be tapped so that the speed drops and a gear can be selected at normal idling speed.

Starting a warm or hot engine

■ Depress pedal slowly **while operating** starter and hold it in the full throttle position – do not pump the pedal!

■ Release the pedal as soon as the engine starts.

Fuel injection engines

These engines are fitted with a fuel injection system which automatically supplies the correct fuel/air mixture for all operating conditions. The starting procedure described here is applicable regardless of ambient or engine temperature:

- Start engine – **do not depress accelerator.**
- Only if the engine does not start the first time, should the accelerator pedal be depressed slowly during the next attempt to start. When engine starts, release accelerator pedal immediately.

Diesel engines

Glow plugs

The engine is fitted with glow plugs. The time the plugs are on is indicated by a lamp which is controlled by the coolant temperature – see page 38.

Cold starting aid

To facilitate easy starting from cold, there is a cold starting device in the injection pump.

The cold starting device is actuated when the knob on the right of the steering column is **pulled out fully.**

Starting a cold engine

- At ambient temperatures of down to -15°C the cold start accelerator knob should be **pulled out fully.**

If the ambient temperatures are lower than this, the knob should only be pulled out **after the engine is firing evenly** – the engine will then start up more easily.

- Turn the ignition key to position 2, the glow plug lamp comes on. It goes out when the ignition temperature is reached (see page 33).

If the warning lamp does not come on when the engine is cold, there may be a defect in the glow plug system – call in expert assistance.

To avoid draining the battery unnecessarily, do not switch any other heavy current consumers on while the glow plugs are on.

- As soon as lamp goes out, start engine. Do not depress accelerator while starting.

If engine only fires irregularly, continue to operate starter a few seconds longer (30 seconds at maximum) until engine runs under its own power.

If engine does not start, switch glow plugs on again and try starting it again as described.

If the engine still does not start, the fuse for the glow plugs may have blown – page 111.

OPERATION

STARTING THE ENGINE

■ Push the cold starting aid knob in fully as soon as the engine has reached normal operating temperature.

Starting a warm engine

The glow plug warning lamp does not come on – the engine can be started straight away.

Do not pull the cold starting aid knob, and do not depress accelerator pedal.

STOPPING ENGINE

Applicable to all engines:

When the vehicle has been driven hard for a while do not switch the engine off as soon as you stop. Let it idle for about 2 minutes to cool it down slightly.

After the engine is switched off, the fan can continue to run for a while (up to approx. 10 minutes) – even with the ignition switched off. It can also switch on again suddenly after a short time has elapsed if the coolant temperature rises due to accumulation of heat.

Applicable to vehicles with catalytic converter*:

The ignition must not be switched off as long as the vehicle is rolling with a gear engaged, otherwise unburnt fuel can pass into the catalytic converter and be burned there, leading to overheating.

WARN

WARN

The layc
on the r
symbols
warning

1 – Brak
2 – Anti
3 – Trail
4 – Turr
5 – Gen
6 – Glov
7 – Eng
8 – High
9 – Co

WARNING LAMPS

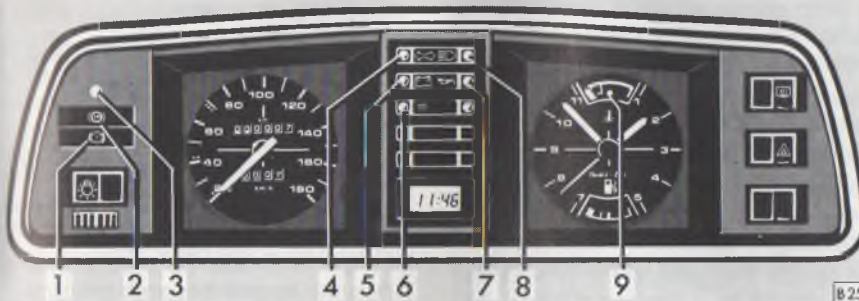

825-590

WARNING LAMPS

The layout of the warning lamps depends on the model and the engine fitted. The symbols shown here are also on the actual warning lamps.

	Page
1 - Brake system	37
2 - Anti-locking brake system (ABS)	37
3 - Trailer turn signals	37
4 - Turn signals	38
5 - Generator	38
6 - Glow plug system	38
7 - Engine oil pressure	39
8 - High beams	39
9 - Coolant temperature/level	39

1 – Brake system (ⓘ)

With the ignition switched on, the warning lamp* comes on when

- the handbrake is applied
- the fluid level is low

Attention

If the lamp does not go out when handbrake is released or comes on when driving, the fluid level in reservoir is too low. If at the same time the pedal free travel increases, one of the two hydraulic circuits may have failed.

You can drive on to the nearest V.A.G Dealership but allow for higher pedal pressure and longer braking distances on the way.

2 – Anti-locking Brake System (ABS)* (ABS)

The warning lamp comes on when the ignition is switched on. It goes out, when engine has been started and the generator warning lamp has gone out. (When a vehicle speed of approx. 6 km/h has been reached, an automatic check sequence takes place. During the check a pump motor noise may be heard.)

If the lamp does not go out, or if it comes on while driving, the system is not in order. The vehicle can then only be braked with the normal brake system and should be taken to a V.A.G Dealership as soon as possible.

Further detail on ABS is given on page 27.

3 – Trailer turn signals*

The warning lamp flashes when turn signals are switched on when towing a trailer.

If a turn signal fails on trailer or vehicle, the warning lamp does not flash.

4 – Turn signals

The warning lamp flashes when turn signals are switched on. If a turn signal fails, the warning lamp flashes twice as fast. (Not when towing a trailer). Further details are on page 45.

5 – Generator

Petrol engines

This lamp comes on when the ignition is switched on and must go out when the engine is started.

If the lamp comes on when driving, **stop at once, switch the engine off** and check the vee belt.

If the belt is broken do not **drive on** because the coolant pump is then no longer being driven. Fit a new belt. (For belt sizes see "Technical data".)

If the warning lamp comes on although the belt is not broken, one can normally drive on to next V.A.G Dealership.

However as the battery is then discharging continuously, all electrical components which are not absolutely essential should be switched off.

Diesel engine

This lamp comes on when the ignition is switched on and must go out when the engine is started.

If the lamp comes on **when driving**, stop at once, switch the engine off and check the vee belts for generator and coolant pump.

If the belt for the coolant pump is broken, do not drive on. Renew the belt – for belt size see "Technical data".

If the belt for the generator is broken, the vehicle can still be driven to the next V.A.G Dealership but the battery will then discharge continuously – see next paragraph.

If the belts are not broken one can normally drive on to the next V.A.G Dealership. As the battery will be discharging continuously, all electrical components which are not absolutely essential should be switched off.

6 – Glow plugs

(Diesel engine only)

When engine is cold, the warning lamp comes on when key is turned to drive position (ignition on).

If the warning lamp does not come on there may be a defect in the glow plug system – call in expert assistance.

When the lamp goes out, start the engine immediately – see page 35.

When the engine is warm the glow plug lamp does not come on – the engine can be started straight away.

7 – Engine oil pressure

This warning lamp flashes when the ignition is switched on. After the engine has started, the lamp must go out again.

If the warning lamp does not go out, or flashes when driving – at an engine speed of approx. 2000 rpm a buzzer will also sound – **stop at once and switch the engine off**. Check the oil level and if necessary, add oil – see page 87.

If the lamp comes on despite the oil level being correct, **do not drive on**. In such a case, **the engine must not be run**, even at idling speed – call in expert assistance.

Note:

The oil pressure warning lamp is not an oil level indicator.

For this reason, the oil level must be checked at regular intervals – see page 87.

8 – High beams

The warning lamp comes on when high beams are on, or headlight flasher is used.

9 – Coolant temperature/ coolant level

This lamp flashes for a few seconds as a functional check when ignition is switched on.

If the lamp does not go out afterwards or flashes when driving, either the coolant temperature is too high or the coolant level is too low.

Stop at once, switch the engine off and check if the radiator fan is running (by listening). The fan is at the front behind the radiator grille. If the fan is not running, check the fuse and replace if necessary – see page 110.

If the fan is in order, check coolant level and top up if necessary.

Attention

Danger of scalding. Before removing the cap, let the engine cool down.

For further details see page 92.

If the warning lamp does not go out even though the coolant level, and fan fuse are in order, **do not drive on** – call in expert assistance.

If the trouble is only caused by the fan, and assuming the coolant level is in order and warning lamp is out – one can drive on to the next V.A.G Dealership. In order to make good use of the air stream for cooling do not let the engine idle or drive very slowly.

Differential locks*

Warning lamps for the differential locks on four wheel drive models – see page 29.

OPERATION

INSTRUMENTS

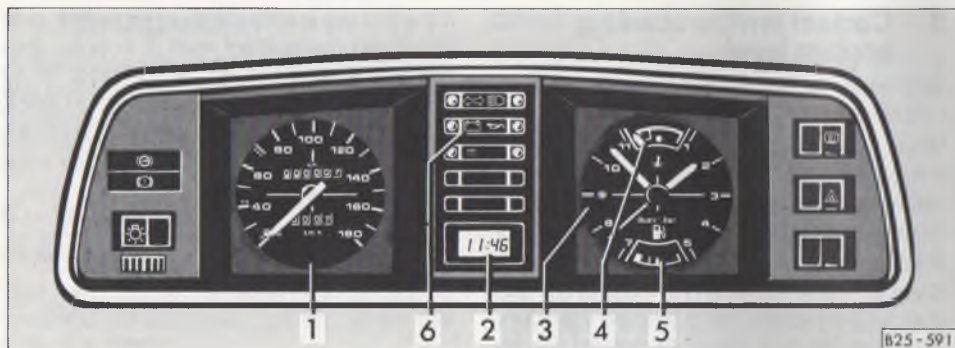

	Page
1 – Speedometer	40
2 – Digital clock	40
3 – Normal clock or Rev counter	41
4 – Coolant temperature gauge	41
5 – Fuel gauge	42
6 – Warning lamps	37

1 – Speedometer

During the running-in period, attention should be paid to the driving tips given on page 63.

Mileage recorder

The upper counter registers the total distance covered, whereas the lower counter* indicates the individual trips.

The last digit of the upper or lower recorder indicates 100 m or one tenth mile.

The trip recorder can be zeroed by pressing the knob in the speedometer dial.

Clock*

2 – Digital clock*

The time is set with buttons on left and right of dial. The left button is for the hours and the right one for the minutes:

■ If pressed briefly, preferably with a ball pen, the time changes one hour or one minute.

■ If pressed continuously the hours and minutes change continuously.

With the minute button the clock can be set exactly to the second.

■ Press button until time is one minute before time to be set.

■ Press button at the moment when the seconds indicator of an accurate clock shows a full minute or when the time signal is heard on the radio.

3 – Normal clock*

To set the time, press knob in centre of dial and turn hands.

3 – Rev counter*

The dotted zone on the scale shows the maximum engine speed permitted briefly when engine has been run in and is warm – see page 63 also. It is advisable to change up or reduce engine speed at the latest by the time the needle reaches this zone.

Changing up in good time helps to save fuel and keeps the noise down.

Always change down to the next lower gear before the engine starts labouring (no longer pulls smoothly).

The green or green shaded area on the scale shows the speed at which the engine is developing its most favourable torque.

High engine speeds should be avoided during the running-in period.



4 – Coolant temperature gauge

The gauge starts to work when the ignition is switched on, but it takes a little time before the needle reaches the final position.

When ignition is switched on the warning lamp (c) flashes for a few seconds as a functional check.

a – Cold zone

Avoid high engine speeds and do not work engine too hard yet.

b – Normal zone

When the vehicle is driven normally the needle should settle down in this zone.

When engine is working hard and the ambient temperature is high, the needle may move well over to the right.

This is not serious as long as the warning lamp (c) does not flash.

c – Warning lamp

If the lamp flashes when driving, either the coolant temperature is too high or the coolant level is too low. Stop at once, switch the engine off and try to find the cause of the trouble – see page 39.

OPERATION



5 – Fuel gauge

The fuel gauge needle starts to move when the ignition is switched on but it takes a few seconds to reach its final position.

The tank holds about 60 litres (syncro; 70 litres).

When the needle reaches the start of the reserve mark (R) there are about 10 litres of fuel left in the tank.

Tachograph*

In many European countries the installation and use of a tachograph is obligatory for certain vehicles.

Details of the regulations can be obtained from local vehicle licensing authorities.

The operation of the tachograph is described in a special leaflet from the tachograph manufacturers.

SWITCHES

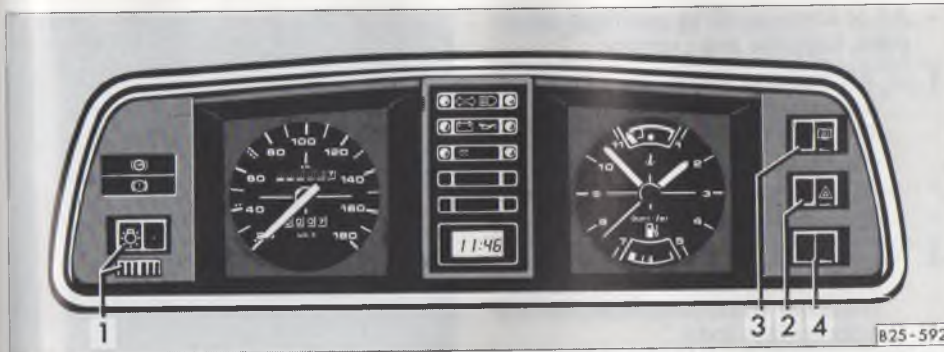
**1 – Lighting switch**

- First detent – side lights¹⁾
 Second detent – headlight high²⁾ or low beams

The headlights only work when the ignition is on. When the engine is being started and after the ignition has been switched off, the headlights are switched off automatically.

When the lights are on, the level of the instrument lighting can be regulated by turning the knurled disc* below the switch.

Dipping and flashing headlights – see page 45.

1) On vehicles for Great Britain (depending on model) the headlights also come on with reduced brightness (Dim-dip lighting) at the first detent when the ignition is switched on.

2) On vehicles with additional headlights in the radiator grille*, these come on together with the high beams.

2 – Emergency lights

When the emergency lights are on, a warning lamp in the switch flashes as well.

The system also works when the ignition is switched off.

3 – Heated rear window*

The heating only works when ignition is on. When heater is on, a lamp in the switch lights up.

As soon as window is clear, switch the element off. The reduced current consumption helps to reduce the fuel consumption – see also "Driving economically".

On vehicles with electrically adjusted exterior mirrors the mirror surface is heated whenever the rear window heating is switched on.

**4 – Fog lights*
rear fog light***

- First detent – fog lights
 Second detent – front and rear fog lights, or only rear fog light.

At the second position a warning lamp in the switch comes on.

The **fog lights** only work with the side lights (ignition on), low or high beams.

The **rear fog light** only works with the fog lights or with the low or high beams.

Due to the amount of dazzle it causes the rear fog light should only be switched on when the visibility is very poor (in the Federal Republic of Germany for example, below 50 metres).

Headlight beam control*

With the electrical beam control the headlight settings can be matched exactly to the load condition of vehicle. This prevents oncoming traffic from being dazzled more than is unavoidable. At the same time the correct headlight beam setting provides the best possible visibility for the driver.

The headlights can only be regulated with the low beams switched on.

To lower the beams turn knurled disc from the basic position (–) downwards.

On models which are registered as cars the knurled wheel is provided, in addition to the horizontal line for the basic setting, and the adjustment positions 1, 2 and 3.

The adjustment settings correspond roughly with the following loads:

– All or some seating positions occupied, luggage area empty

1 – All seating positions occupied, luggage area evenly loaded up to the maximum rear axle loading figure.

2 – Five seating positions occupied, luggage area fully laden.

3 – Drivers' seat occupied, luggage area evenly loaded up to the permissible maximum load for the appropriate axle.

Intermediate settings can be selected to allow for various loads.

Note

The basic headlight setting (only possible with a setting appliance) must always be carried out with the knurled wheel in the basic position (–).

Note

The use of the lighting described is subject to local regulations.



Knurled disc for seat heating*

The cushion and backrest of the driver's seat can be heated electrically when the ignition is on.

The heating is switched on and regulated with the knurled disc.

To switch the heating off, turn the knurled disc to the detent position.

TURN SIGNAL AND DIP LEVER



The turn signals only work when the ignition is switched on.

Right turn signals – lever up
Left turn signals – lever down

When turn signals are working, the warning lamp flashes as well. See page 38 also.

On vehicles with additional headlights in the radiator grille*, these come on together with the high beams.

When a turn signal fails, the warning lamp flashes roughly twice as fast.

The turn signals cancel automatically after completing a turn.

To signal a lane change

Move the lever up or down to the pressure point and hold in this position – the warning lamp must also be flashing.

To dip headlights

Pull the lever past the pressure point towards the steering wheel. When the high beams are on¹⁾, a warning lamp in the dash lights up.

Headlight flasher

Pull the lever towards the steering wheel to pressure point – the high beam warning lamp lights up.

Parking lights*

The parking lights only work when the ignition key is removed.

Right parking lights – lever up
Left parking lights – lever down

Note

When using the signal and lighting facilities described, attention must be paid to the legal requirements.

¹⁾ On vehicles for Great Britain (depending on the vehicle type) the headlights are dimmed (reduced brightness (Dim-dip lighting) at the first detent when the ignition is switched on.

OPERATION

CRUISE CONTROL SYSTEM *

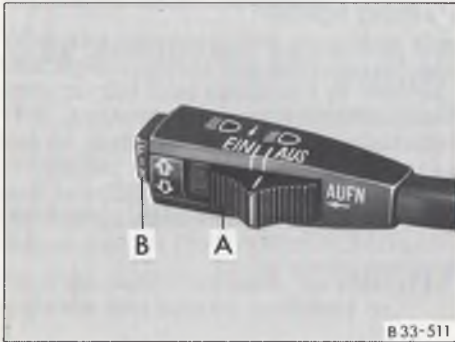

With this system any desired speed from about 35 km/h can be held constant (insofar as engine output permits).

This means that the driver does not have to keep the accelerator constantly depressed on long journeys.

Attention

- The cruise control system should not be used in dense traffic and when the road conditions are poor (slippery surfaces, aquaplaning, gravel).
- When system is switched on do not move into neutral at speeds above 30 km/h without depressing the clutch pedal otherwise engine will race and could, under certain circumstances, become damaged.

The system is **operated** with the sliding button A and the press button B on the turn signal lever.

The system is **switched on** by moving button A to EIN.

When the speed to be maintained has been reached the press button B must be pressed briefly. The foot can then be taken off the accelerator pedal.

The programmed speed can also be increased without pressing the accelerator pedal. The press button B need only be pressed until the desired speed has been reached.

The speed can also be increased in the normal way with the accelerator pedal. When the pedal is then released the previously programmed speed is resumed.

The system is **temporarily switched off** when the brake or clutch pedals are used or when the speed is considerably below the programmed speed i. e. when driving up a steep gradient in too high a gear.

To resume the speed previously programmed when the brake or clutch pedals are released, or at end of gradient, push button A to the left (AUFN).

Attention

The programmed speed must only be resumed when it is not too high for the existing traffic conditions.

The system is **completely switched off** by moving the switch to the right (AUS), or by switching the ignition off.

WINDSCREEN WIPER AND WASHER SYSTEM



Wipers and washers only work when the ignition is switched on.

When it is freezing, check that the wiper blades are not frozen to the glass before switching the wipers on for the first time.

Windscreen

Brief wipe: Lift the lever to the pressure point before stop 1.

Wiper slow: Lever at position 1.

Wiper fast: Lever at position 2.

Windscreen washer

Pull the lever towards the steering wheel – the system works as long as the lever is held in this position.

Automatic wash/wipe facility*

Pull the lever towards the steering wheel – wipers and washer work.

Release lever.

The washer stops and the wipers carry on for about 4 seconds.

Lever at detent 3

The wipers work about every 6 seconds (intermittent wipe).

Rear window**Automatic wash/wipe***

Press the lever briefly away from the steering wheel – the wiper works about every 6 seconds (intermittent wipe). Pressing the lever briefly again switches the wiper off.

Press the lever away from the steering wheel, and hold in this position –

The wiper and washer work as long as the lever is held in this position.

Release lever –

The washer stops and the wiper carries on for about 4 seconds.

Headlight washer system*

When the headlights are on, the lenses are washed every time the windscreen is washed.

At regular intervals such as when filling the tank, caked on dirt and insects should be removed.

Filling the washer container, see page 97.

OPERATION

HEATING AND VENTILATION

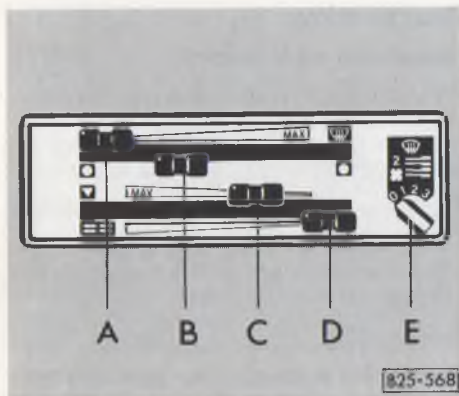

Controls

Levers A and C – Warm or fresh air distribution

Lever A to right – vents 1 and 2 are opened

Lever C to left – vents 4 and footwell vents in passenger compartment* are opened.

Lever B – Heat output

To right – increases

To left – decreases

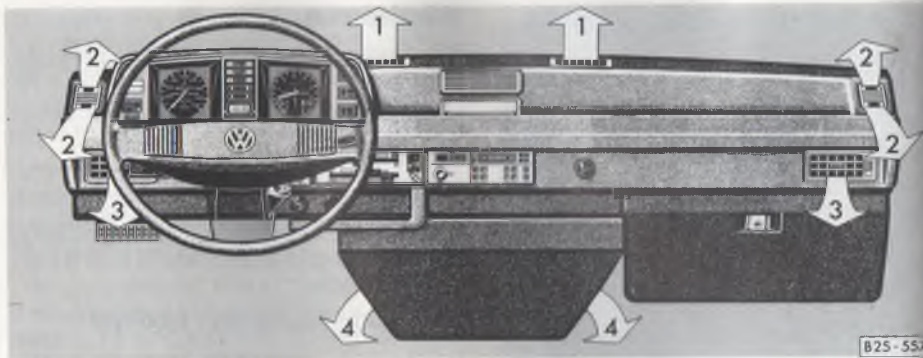

Lever D – Roof vents in passenger compartment*

To right – fresh air decreases

To left – fresh air increases

Note:

To distinguish better from the other levers, there are small knobs on levers B and D which can be distinctly felt.

Switch E – Blower

The blower has 3 speeds.

Air vents

Depending on the position of the lever heated or unheated fresh air flows from the vents.

The vents 3 can also be opened and closed separately:

knurled disc downwards – vent opened

knurled disc upwards – vent closed

By swinging the complete outlet grille of vents 3 the air flow can be moved vertically.

When the lever in the grille is moved to the front, the air flow direction is altered laterally.

Defrosting windscreen and side windows

- Move all levers fully to the right.
- Switch blower to stage 2 with switch E.
- Switch off blower of additional heat exchanger*.

Demisting windscreen and side windows

When the windows mist up due to high air humidity, e.g. when it is raining, we recommend the following setting:

- Move levers A, C and D fully to the right.
- Move lever B slightly to the right into the heating range, if necessary.
- Blower switch E to stage 2 or 3.
- Close vents 3.

Heating interior as quickly as possible

- Levers A, B + D fully to the right
- Lever C fully to the left
- Close vents 3
- Switch blower to stage 2 with switch E.

Heating interior normally

When the windows are clear and the desired temperature has been reached, we recommend the following settings:

- Lever A to the left
- Lever B to the desired heat output
- Lever C to the left
- Blower switch E at stage 1

Ventilation

When heating is off, fresh air flows from all vents.

Notes

- To ensure that the heating and ventilation works properly, the blower should always be switched on when driving slowly.
- To prevent contaminated air from entering the vehicle, move lever A fully to left and levers C and D fully to right. The vents 3 must also be closed.
- The heat depends on the engine temperature – the full heat output is therefore only available when engine is warm.
- All controls except blower switch E can be set to any intermediate position.
- Depending on vehicle model the stale air can escape either through slots in the front doors or through slots in the rear side windows.

The slots in the front doors can be opened or closed by means of slides.

49,91
0,35
59,26

313,9 miles
÷ 59,26 litres

OPERATION

HEATING AND VENTILATION



Additional heat exchanger* for the passenger compartment

The additional heat exchanger is located under the rear seat. The blower is controlled by a 3 stage switch on the dash panel – see left hand illustration.

To obtain warm air from the heat exchanger, the valve on the heat exchanger must be fully open.

To close or open the valve, the trim under the rear seat must be removed.



To do this, grip the trim on the left side and pull it out. Then move the valve lever as shown above.

Lever upwards – opened (Winter position)

Lever to rear – closed (Summer position)

In the warm season the heat exchanger blower can be used to circulate the air. When used in this way the valve on the heat exchanger should be closed. This will prevent unnecessary heat radiation reaching the footwell when the weather is warm.

AUXILIARY AIR HEATER*

The heater is switched on and off with the knob (see Fig.) in the dash on the right of the steering column. This switch also regulates the amount of heat.

Depending on model concerned the warm air flows from the footwell vents in the passenger compartment and/or from a controllable vent under the driver's seat. The air distribution cannot be regulated.

The heater can be used all the time the vehicle is moving. When the engine is not running the heater switches off automatically after about 15 minutes, to avoid draining the battery.

The heater is supplied with fuel from the vehicle tank. It can use up to one litre per hour according to operating conditions.

The heat output is about 7 kW (6000 kcal/h).



Switch positions

- 0 – Heater off
- 0 to 1 – Heating with engine not running
- 2 – Heating when driving
- 2 to 3 – Regulates amount of heat

Note:

On RHD vehicles the additional heater switch knob can be fitted with a 90° clockwise turn.

Heating with engine stationary

(Ignition off)

To switch heater on –

Press the switch knob in at position 0 and turn it clockwise towards 1 (warning lamp lights up). The knob springs out again when released.

The amount of heat can be regulated between 2 and 3 as required.

Note:

On vehicles with Diesel engine it takes about 40 seconds before the heat can be felt.

To switch heater off –

The clockwork mechanism in the temperature regulating switch switches the heater off automatically after about 15 minutes and the lamp goes out.

To switch the heater off before clockwork mechanism has run down: turn the knob anti-clockwise to 0. The lamp goes out and the clockwork mechanism runs down.

OPERATION

Heating when driving

To switch the heater on –

Turn the switch knob clockwise to position 2 (warning lamp in knob comes on)

The amount of heat can be regulated between 2 and 3 as required.

Note

On vehicles with Diesel engine it takes about 40 seconds before the heat can be felt.

To switch the heater off –

Turn the switch knob anti-clockwise to position 0 (warning lamp goes out)

Notes

■ Every time the heater is switched off, the warm air and combustion air blowers continue running briefly to cool the heater down quicker.

■ To avoid draining the battery, do not run the heater repeatedly when the engine is not running.

■ When the heater is running on the clockwork time switch, it must be switched off by hand before attempting to start the engine at low temperatures so that the full battery capacity is available to turn the engine.

Attention

■ In enclosed spaces and when filling the fuel tank, the heater must be switched off.

Due to the risk of fire the heater must not be used when vehicle is parked, for instance on dry grass or leaves.

Maintenance

■ When driving through mud and snow the exhaust pipe may tend to become blocked. Have a look at it occasionally to see that it is clear.

■ According to official German regulations:

The heat exchanger in the heater is only to be used for 10 years. After this period the heat exchanger must be replaced in a V.A.G Dealership. The year in which the heater is first put into operation is marked on the nameplate on the heater.

The V.A.G Dealership must then put the date of the exchange on the plate on the heat exchanger.



Defects

The heater on vehicles with a **petrol engine** has a safety switch which is located under the dash panel, on the left near the steering column. If the heater does not start, or starts and then stops again, wait 3 minutes and then operate the red lever on the safety switch.

If the heater still does not work, or if the safety switch stops it again, there is a defect in the heater which can only be repaired by a V.A.G. Dealership.

If the heater on vehicles with a **Diesel engine** will not start or stops after operating for a while, an automatic cut-out switches the heater off. If the heater cannot be started by switching the rotary switch off and on, the heater is defective and must be repaired in a V.A.G. Dealership.

Fuses

See page 110.

OPERATION

AUXILIARY WATER HEATER*(syncro)

The auxiliary heater heats the coolant in the heating circuit and supplies the heat exchanger in the normal heating system, and the additional heat exchanger* for the passenger compartment heating, with heated coolant. The coolant circuit of the engine is not heated.

The system is switched on and off or the switch-on time preselected by means of a switch and indicator unit located on the left (or right) under the instrument panel.

Air distribution and regulation is done with the controls of the normal heating and ventilation system (see page 48).

The auxiliary heater can be used with the vehicle stationary or when it is moving. When the vehicle is stationary, the heater only runs for a maximum of 30 minutes, to avoid draining the battery. It also switches off automatically when a coolant temperature of 80 °C is reached.

When the coolant temperature drops below 70 °C the heater is automatically switched on again.

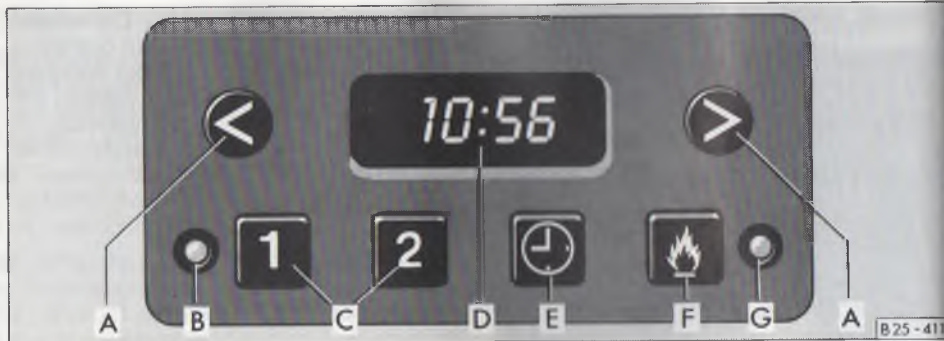

The heater is supplied with fuel from the vehicle tank and uses up to half a litre per hour. The heat output is about 4.5 kw (4000 kcal/h).

Controls

- A – Buttons for setting time and preselected time.
- B – Indicator lamp for preselected time
- C – Preselected time
- D – Display
- E – Actual time
- F – Heater on/off
- G – Warning lamp (heater on)

Setting

- Press
- Set th

The displayed time is set by pressing the left arrow button. The display shows the selected time in seconds.

To switch

- This is the heater on/off button. G lights the heater on/off lever for the right.

Preselected

(stationary). With the vehicle stationary, the heater only runs for a maximum of 30 minutes.

- Press the heater on/off button. The real

Setting the time

- Press and hold the clock button E.

- Set the clock with buttons A.

The display lights up as long as button E is pressed. When the button is released the display goes out or, if a time has been pre-selected, the selected time lights up for 2 seconds.

To switch the heater on or off

- This is done by pressing button F. When the heater is switched on the warning lamp G lights up. The heater can only work if the lever for the heat output is pushed fully to the right. This closes an electrical contact.

Preselecting starting time for heater

(stationary operation, ignition off)

With buttons C two different switch-on times can be selected within 24 hours.

- Press and hold the button. The appropriate figure 1 or 2 appears in the display. The ready-for-action lamp lights up.

- Set the required switch-on time with buttons A. The display remains on for about 20 seconds after releasing button C.

To ensure that the heater starts up at the selected time, the lever for the heat output must be pushed fully over to the right. In addition to this the blower must be switched to stage 1. On account of the higher current consumption, a higher stage should only be selected in isolated cases.

Switching preselected time off

- The preselected time can be switched off by briefly pressing the appropriate button C. The ready-for-action lamp and the figure in display then go out.

Fuses

See page 110.

Notes

- Every time the heater is switched off, the warm air and combustion air blowers continue running briefly to cool the heater down quicker.

- To avoid draining the battery, do not run the heater repeatedly when the engine is not running.

- When driving through mud and snow, the exhaust pipe may tend to become blocked. Have a look at it occasionally to see that it is clear.

According to official German regulations:

The heat exchanger in the heater is only to be used for 10 years. After this period the heat exchanger must be replaced in a V.A.G Dealership. The year in which the heater is first put into operation is marked on the nameplate on the heater.

The V.A.G Dealership must then put the date of the exchange on the plate on the heat exchanger.

Attention

- In enclosed spaces, and when filling the fuel tank, the heater must be switched off.

OPERATION

AIR CONDITIONER*

The air conditioner is located under the roof in the cab and in the passenger compartment. It works on the recirculation principle independently from the normal heating and ventilation system. The air is drawn in via an intake grille in the rear part of the system. The cooled air flows from the outlets under the vehicle roof.

The operating switches are located in the dash panel (see left hand Fig.).

The air conditioner only works when the engine is running and when the ambient temperature is above about +5 °C.

When the system is switched on it reduces not only the temperature inside the vehicle but also the air humidity.

This prevents the windows from misting up when the humidity of the ambient air is high. The system is most efficient when the windows are all closed. However, when the interior is very hot after vehicle has been standing in the sun for a long time, it is advisable to open windows and doors so that the hot air can escape.



Controls

A – Blower switch

The blower has 4 speeds.

B – Temperature control switch

This switch gives infinite regulation of the temperature.

- Turning to right – Colder air
- Turning to left – Warmer air

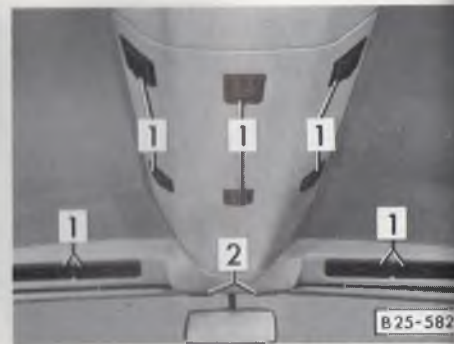

Air outlets

The direction of flow from vents 1 can be altered. The vents can also be closed completely.

- To adjust, move the vent element or turn the knurled disc.
- To close, turn the knurled disc to right or left as far as possible.

The vents 2 can also be adjusted.

- To adjust, turn the complete vent.

How to use system

Normal cooling

- Set the blower switch A to stage 1 or 2.
- Adjust the air temperature as desired with switch B.
- Set the outlet vents as required.

Maximum cooling

- Set the blower switch A to stage 4.
- Turn switch B fully to the right.
- Set the outlet vents as required.

Notes

Pools of water under vehicle

When the ambient temperature and the air humidity are high, condensed water can drip off the evaporator and form a pool under the vehicle. This is normal and does not mean there is a leak.

Payload reduction

The load capacity is reduced by about 40 kg due to the weight of the air conditioner, and the unladen weight is correspondingly higher – see also "Technical data, Weights" on page 138.

Faulty operation

System does not work

- Ambient temperature may be below +5 °C. When temperature is under +5 °C the air conditioner is switched off automatically.
- The fuse may have blown. Check fuse and renew if necessary. The fuse is No. 12 – see page 111 – in the fuse box.

OPERATION

SLIDING ROOF*



The roof is opened and closed with the crank above the driver's seat:

To **open** – Fold the crank down and turn it to the left, then fold the crank into recess again.

To **close** – Fold the crank down and turn it to the right as far as it will go then turn it back until it can be folded into the recess.

Attention

For safety reasons, the crank should always be in the recess.

If the roof becomes hard to operate after a while, the runners should be cleaned and greased – see page 80.

SUN ROOF*

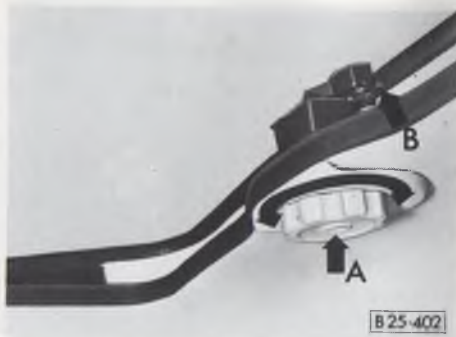

The roof is opened and closed with the knurled disc in the headlining above the front seats.

The roof can be tilted at the rear as desired or taken out altogether.

Raising

Turn the knurled disc clockwise.

Lowering

Turn the knurled disc anti-clockwise.

To take out

- Turn the retaining screw (A) in centre of the knurled disc one quarter turn clockwise (e.g. with a coin) with the roof closed.
- Then raise the roof and press it up.
- Press locking lever (B) up.
- Detach the roof.
- Lift the roof from outside and pull it out to the rear.

To put back

- Slide the roof back into the hinges and let it drop lightly into the retainers.

Attention

Ensure that the roof is properly inserted into the two retaining hinges at the front, and locked at the rear.

The roof must only be unlocked when vehicle is stationary.

INTERIOR LIGHTS

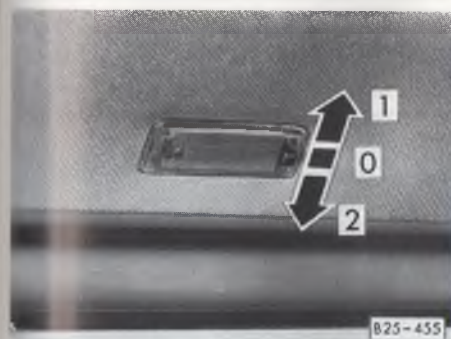
**Light above driver's seat**

Switch positions:

- 1 – Light on continuously
- 0 – Off
- 2 – Door contact position, light comes on when the cab doors are open.

Step light*

The step light comes on when the sliding door is opened. It goes out a few seconds after the sliding door has been closed.

Table light*

Switch positions:

- To front – On
- To rear – Off

**Reading lamps***

The reading lamps have separate switches and can be swivelled about as required.

Switch positions:

- Ring turned to the right – On
- Ring turned to the left – Off

The reading lamp on the right at the rear, lights up continuously when the sliding door is opened. When the sliding door is closed it goes out in the off position together with the step light after a delay of a few seconds.

**Reading lamp in front of passenger seat***

Switch positions:

- Up – Off
- Down – On

Luggage compartment lights*

The luggage compartment lights come on when the tailgate is opened.

Note

When leaving the vehicle ensure that all lights are switched off to ensure that the battery is not run down when the vehicle is left standing for some time.

OPERATION

SUN VISORS



Both sun visors can be lifted out of their brackets and swung round towards the doors.

An illuminated make-up mirror* is fitted at the back of the passenger's sun visor.

To switch the light on – move the switch to the left.

When the sun visor is moved up, the mirror illumination goes out automatically.

Note

When leaving the vehicle always ensure that the light is switched off to ensure that the battery is not run down when vehicle is left standing for a long time.

ASHTRAYS

Ashtray in dash

To take out:

Grip the strip on the opened lid and lift at one side.

To insert:

Press the ashtray into the opening with the lid closed.

Ashtray in passenger compartment

To take out:

Open the ashtray, press down and take it out.

To insert:

Insert at the top first then push it in fully.

On vehicles with individual seats:

To take the ashtray out:

Lift one side of the handle of the opened lid.

To insert the ashtray:

Push the ashtray into the opening with the lid closed.

CIGARETTE LIGHTER/SOCKET*

The **cigarette lighter** is switched on by pushing in the element.

When the heating element glows, the lighter springs out automatically – pull it out immediately.

The **socket** can be used for a cigarette lighter or other electrical accessories with a capacity of up to 100 watts. When the engine is not running this will however soon discharge the battery.

Attention

The cigarette lighter and socket also work when the ignition key has been taken out.

Children should therefore never be left alone in the vehicle.

GLOVE BOX

Vehicles with a lockable glove box have an additional key – see also page 7.

To open the lid, squeeze both buttons together.

Attention

For safety reasons, the lid* should always be closed when the vehicle is moving.

CURTAINS*

The curtains which can be supplied for vehicles with seats/reclining seat bench are stored underneath the rear seat. They are secured to the passenger compartment window surrounds by press studs. A further curtain can be press-studded in position behind the front seats.

TABLE*

On vehicles with individual seats in the passenger compartment there is an extending table on the left side.

The table can be pulled up out of its retainers and folded down (see illustration).

Attention

For safety reasons, the table must be pushed in when the vehicle is moving.

OPERATION

CANOPY* (Pick-up)



The canopy must be secured properly behind the cab.

The canopy is correctly secured when the rod incorporated in the canopy engages in the rain channel at the rear of the cab and the left and right hand ends are bolted to the canopy frame.

When the canopy and rails have been removed, care should be taken when refitting to ensure that the foam seal is stuck properly in the rain channel (if necessary renew seal).

DROPSIDES (Pick-up)



To drop the side boards – pull the handle outwards to release the locking pin and swing down to lift the hook.

On vehicles with support cables for the tailboard, not more than 150 kg should be placed on the tailboard when it is down.

ROOF RACK

When a roof rack is to be used, note the following:

- Only use roof racks which are supported in the rain channel
- Distribute the load uniformly. Do not exceed the permissible roof load or permissible gross vehicle weight. Further details on page 138.
- When carrying heavy or large objects on the roof, bear in mind that the vehicle handling changes due to the alteration in centre of gravity and the increased area exposed to the wind. Driving style and speed must be adapted to allow for this.

THE FIRST 1500 KM – AND AFTERWARDS

During the first few operating hours the engine internal friction is higher than later on when all the moving parts have bedded down. How well this running in process is done depends to a considerable extent on the way the vehicle is driven during the first 1500 km.

Up to 1000 km

the following general rules are valid:

- **Do not use full throttle**
- **Do not drive faster than $\frac{3}{4}$ of top speed**
- **Avoid high engine speeds in all gears**

From 1000–1500 km

The speed can gradually be increased to the road or engine maximum.

After the running-in period

On vehicles with a rev counter one should change into the next higher gear at the latest by the time the red warning zone is reached.

The maximum permissible engine speeds for continuous operation are:

Petrol engines	about 5400 rpm
Diesel engines	about 4600 rpm
Turbo Diesel engines	about 4800 rpm

In exceptional cases however, e.g. when overtaking, the shaded area on the speedo scale can be entered briefly – refer to page 41 as well.

In the case of Diesel engines extremely high engine speeds are prevented by an automatic governor.

Applicable during and after the running-in period:

- Do not **overrev** the engine when cold – either in neutral or in the gears. All speeds and revs are only valid when the engine is properly warm.
- *Do not drive with the engine speed unnecessarily high – changing up early helps to save fuel and reduces noise.*
- Do not let the engine labour – change down when the engine no longer runs smoothly.
- During the running-in period, trailer towing should be avoided as far as possible.
- New tyres must also be “run in” because they do not have maximum adhesion at the start. This must be taken into account by driving carefully during the first 100 km.
- New brake linings must also be run in and do not have the optimum friction properties during the first 200 km. The slightly reduced braking effect can be compensated for by slightly more pressure on the brake pedal. This also applies when new linings have been fitted.

DRIVING TIPS

DRIVING SAFELY

The operational condition of your vehicle is essential to safe driving.

So before moving off, always check the following points:

- **Lights and turn signals**
- **Brakes**
- **Amount of fuel**
- **Mirror settings**
- **Cleanliness of headlights, lenses and windows**

Also check at regular intervals:

- **Tyre condition and pressures** – pages 99–101, 137.
- **Engine oil level** – page 87.

The oil level must be checked every time fuel tank is filled, or daily under arduous conditions or full throttle operation.

- **Coolant level** – page 92.
- **Brake fluid level** – page 94.
- **Fluid level in windscreen washer** – page 97.

- **Condition of windscreen wiper blades** – page 98.

Furthermore compliance with the specified inspection intervals – in particular the brake fluid changing is of great importance for driving safety – pages 83, 94.

Safety on the road depends to a large extent on the personal attitude and style of driving.

To be on the safe side you should:

- **Always put the seat belt on before moving off – even in town traffic** – page 13.

In many countries the wearing of seat belts is compulsory anyway.

- **Ensure that all your passengers – including those on the rear seat – are wearing their belts in the proper manner** – page 13.

Passengers without seat belts not only endanger themselves, but also the driver.

- **Adjust head restraints to body size.**

The upper edge of head restraint must be approximately at eye level.

Ensure that no articles interfere with operation of pedals – page 25.

- **Stow all luggage correctly in luggage compartment** – page 24.

on the roof rack – page 62.

- **Do not drive when you feel tired.**

Stop for a break at the latest after driving for two hours.

- **Never drive when your reactions are impaired in any way.**

Not only alcohol but drugs and many medicines can also be very detrimental to your reactions.

- **Adapt the vehicle speed to the traffic and road conditions.**

Remember that particularly on smooth slippery roads the handling and braking – even on vehicles with four-wheel drive – is limited by the adhesion of the tyres. On wet roads the front wheels can aquaplane at high speeds. The vehicle can then no longer be steered properly.

Further instructions on safety are given in the various chapters in this manual.

DRIVING ECONOMICALLY AND ENVIRONMENT CONSCIOUSLY

Various factors contribute to fuel consumption, the environmental burden and the wear on the engine, brakes and tyres.

This section deals with the points which are significantly important.

The personal style of driving

determines to a great extent the economical aspect and the exhaust and noise development:

■ Do not warm up the engine with the vehicle stationary.

At idling speed it takes a very long time until the engine becomes operationally warm. However, in the warm-up phase, wear and the discharge of pollutants is particularly high. For this reason, drive off immediately the engine has started and avoid high engine speeds.

■ Avoid full throttle acceleration.

Not only is the fuel consumption reduced considerably if one accelerates with feeling, but also the disturbance to the environment and the wear are reduced.

■ Do not drive with high engine speeds.

The most favourable fuel consumption and the least disturbance to the environment are attained at low engine speeds and in the highest possible gear. The fuel consumption is for example more than twice as high in 2nd gear than it is in top gear. At the same

time, the reduced engine speed means a reduction in engine noise. For these reasons therefore one should drive as often as possible, and as long as possible, in the highest gear.

■ Change down only when engine no longer runs smoothly.

Depending on the gearbox fitted one can normally drive on the level in the highest gear at 40–60 km/h and still accelerate.

■ Try not to drive at maximum speed.

The fuel consumption, exhaust pollution and noise increase disproportionately at high speeds. If approximately only 3 quarters of top speed is utilised, the fuel consumption will be reduced by about half. Experience has shown that the loss in time is only marginal.

■ Drive as smoothly as possible and look well ahead.

Unnecessary acceleration and braking must be paid for with higher fuel consumption and more disturbance to the environment.

■ Switch the engine off during traffic hold-ups.

The individual operating conditions naturally also affect the fuel consumption.

The following factors for instance are not favourable to good fuel consumption:

■ Traffic density, particularly large towns with numerous traffic lights.

■ Frequent stop/start driving, particularly driving from house to house so that the engine is never properly warm.

■ Driving in heavy, slow moving traffic in low gear so that the engine speed is relatively high in relation to the distance covered.

One should therefore, plan trips in advance to avoid unfavourable operating conditions.

Obviously the fuel consumption is also affected by factors over which the driver has no control. It is for example normal for the consumption to increase in the winter or in arduous conditions (bad roads, trailer towing etc.).

DRIVING TIPS

The technical prerequisites for a low fuel consumption and efficiency were "built in" at the factory. Particular importance was placed on the lowest possible disturbance to the environment. To retain and make the best possible use of these characteristics attention should be paid to the following points:

■ **Vehicles fitted with a catalytic converter may only be driven on unleaded petrol**

■ **Even those vehicles which do not have a catalytic converter should be driven on unleaded petrol for the sake of the environment.**

■ **The prescribed maintenance operations should be carried out exactly as specified in the Service Schedule – see also page 83.**

Having your vehicle regularly serviced by a V.A.G Dealership not only ensures that it is always operationally fit, but it also ensures economy, lowest possible burden on the environment and a long service life.

■ **Check the tyre pressures every 14 days.**

Low tyre pressures increase the rolling resistance. This not only increases the fuel consumption and tyre wear, but the handling is also impaired.

■ **Do not carry unnecessary ballast in the luggage boot.**

Particularly in town traffic when one has to accelerate often, weight has a great influence on the fuel consumption.

■ **Remove roof rack immediately after use.**

Particularly at high speeds the increased air resistance makes itself felt.

■ **Electrical consumers should only be switched on when they are actually required**

Heated rear windows, additional driving lights and heater blower consume a considerable amount of current. The higher generator load also increases the fuel consumption. For instance, over a period of 10 hours, the heated rear window will increase the fuel consumption by approximately 1 litre.

■ **Check the fuel consumption regularly.**

The fuel consumption should be checked each time the tank is filled up. By doing this inconsistencies on the vehicle which lead to an increased fuel consumption can be discovered sooner.

■ **Check the engine oil level each time the tank is filled up.**

The oil consumption depends to a great extent on the engine load and speed. Depending on the style of driving the consumption can be as much as 1.5 ltrs./1000 km.

It is normal for the oil consumption of a new engine to reach its lowest value after a certain mileage has been covered.

The consumption cannot be properly assessed until the vehicle has run approx. 5000 km.

This also applies to the fuel consumption and the engine output.

TRAILER TOWING

The vehicle is intended mainly for the transportation of persons, luggage and other loads but it can, with the appropriate technical equipment, also be used to tow a trailer.

Trailer towing not only places more stress on the vehicle, it also calls for more concentration from the driver.

For this reason, the operating and driving instructions on the next pages must be strictly adhered to.

Technical requirements

If the vehicle is supplied with a factory-fitted towing bracket, all that is technically and legally necessary for trailer towing will have been taken into account. The free terminal (54 g) in the trailer socket may (in the Federal Republic of Germany) only be used for feeding a rear fog light on the trailer. Other additional consumers (e.g. caravan refrigerator and interior lighting) may only be supplied via a 2nd socket.

If the vehicle is to be subsequently fitted with a towing bracket, the following must be noted:

■ The towing bracket is a safety part. Only a bracket which has been designed and type-approved for this vehicle may be used. It is advisable to use towing brackets from the V.A.G range of accessories as these are identical to the ones fitted by the factory. The fitting instructions supplied with these brackets have been approved by the factory.

■ The trailer socket must be connected properly to the electrical system of the vehicle. This applies, where necessary to the terminal 54g in the socket.

■ As the factory installation of a towing bracket includes the modification of the cooling system, this should also be done when service installing a bracket. Otherwise overheating may occur when the engine is pulling hard (mountains, high ambient temperatures, heavy trailer loads).

Certain vehicle versions can be equipped with a heavy-duty cooling system ex-factory, even though the vehicle is delivered without a towing bracket. Details can be obtained from V.A.G Dealerships.

■ V.A.G Dealerships have all the necessary information about the installation of towing brackets and the fitting of a heavy-duty cooling system. The installation should therefore be done by them.

Operating instructions

■ If the traffic behind the trailer cannot be seen properly with the standard rear view mirrors, additional outside mirrors will be necessary. Both outside mirrors must be fitted on folding arms and adjusted to give a good view to the rear at all times.

■ Pitching movements between towing vehicle and trailer can be reduced by heavy-duty springs and shock absorbers on the rear axle. If these springs and shock absorbers have not already been fitted at the factory, they can, in many cases, be service-installed by V.A.G Dealerships.

■ Pitching and snaking movements can also be reduced by stabilizers which can be obtained from and fitted by V.A.G Dealerships in most European countries.

DRIVING TIPS

■ The permissible trailer weight – see page 141 – must not be exceeded on any account.

■ When towing a trailer in mountainous regions, note that the trailer weights given in the "Technical data" are only valid for gradients up to 10 or 12%. If the trailer weight is below the permissible maximum a correspondingly steeper gradient can be climbed.

■ The given trailer weights are only applicable for altitudes up to 1000 m above sea level. As with increasing height the engine output and thus the climbing ability drops due to the decreasing air density above 1000 m, the weight of vehicle and trailer must also be reduced by 10 % for each further 1000 m or part thereof.

■ Where possible make full use of the maximum permissible drawbar weight on the towing bracket ball – see page 141 – but do not exceed it.

■ While observing the permissible trailer and drawbar weight, distribute the load in the trailer so that heavy objects are as near as possible to the axle. The objects must also be secured so that they cannot slide about.

■ Check the tyre pressures on the towing vehicle and on the trailer.

■ The headlight settings must be checked with the trailer attached before moving off, and altered as necessary.

Driving tips

To obtain the best possible handling of vehicle and trailer, the following should be noted:

■ Try to avoid driving with an unladen vehicle and a loaded trailer. If this cannot be avoided, only drive slowly to allow for the unfavourable weight distribution.

■ As the driving stability of the vehicle and trailer decreases when the speed increases do not drive at the maximum permissible top speed in unfavourable road, weather and wind conditions – particularly when going downhill.

In any case the speed must be reduced immediately the trailer shows the slightest sign of snaking. On no account try to stop the snaking by accelerating.

■ For safety reasons one should not drive faster than 80 km/h (50 mph). This also applies in countries where higher speeds are permitted.

■ Always brake in good time. If the trailer has an overrun brake, apply brakes gently at first then brake firmly. This will avoid the jerking caused by the trailer wheels locking. Change down before going down a steep hill so that the engine can act as a brake.

■ The cooling effect of the radiator fan cannot be increased by changing down because the speed of the fan is not dependent on the engine speed. One should therefore not change down even when towing a trailer as long as the engine can cope without the vehicle speed dropping too much.

Genera

■ Durin
towing a

■ It is
viced be
is used

■ The
the data
test cert
the vehi
figures,
and in th

■ The
laden w
payload

General notes

- During the running-in period avoid trailer towing as far as possible.
- It is advisable to have the vehicle serviced between the inspection intervals if it is used frequently for towing a trailer.
- The trailer and drawbar load figures on the data plate of the towing bracket are for test certification only. The correct figures for the vehicle, which are lower than the above figures, are given in the vehicle documents and in this manual.
- The towing bracket increases the unladen weight of the towing vehicle and the payload must be reduced to correspond.

In some countries (for example the Federal Republic of Germany) the following additional legal requirements apply:

- A special warning lamp must be fitted within the driver's range of vision to show that the trailer turn signals are working.
- The maximum drawbar weight – see page 141 also – must be shown on a clearly visible sticker at the rear of the towing vehicle.
- The installation of a towing bracket must be passed by a legally approved test centre – e.g. TÜV – and then proof of installation is entered in the vehicle documents by the traffic authority.
- The maximum speed permissible when towing a trailer is 80 km/h (50 mph).
- Furthermore, if the vehicle is registered as a commercial vehicle, there may be restrictions on driving and trailer towing on Sundays and public holidays.
- If the combined GVW of vehicle and trailer exceeds 3.5 t, the installation and use of a tachograph is compulsory – see page 42.

DRIVING TIPS

DRIVING A FOUR-WHEEL DRIVE VEHICLE*

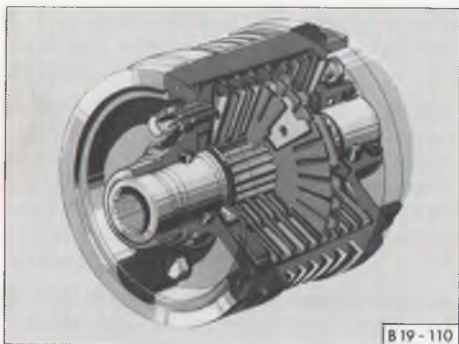

The drive concept

Contrary to the normal type of selectable four-wheel drive, the four-wheel drive on the Transporter/Caravelle syncro is always in action. Only the amount of power being transmitted to the front and rear wheels changes according to the requirements. This automatic distribution of the driving forces is attained through a wear resistant viscous coupling incorporated in the front axle. This ensures, on the one hand, that the driving force losses are kept as low as possible, and on the other hand, that the best possible traction is attained when required.

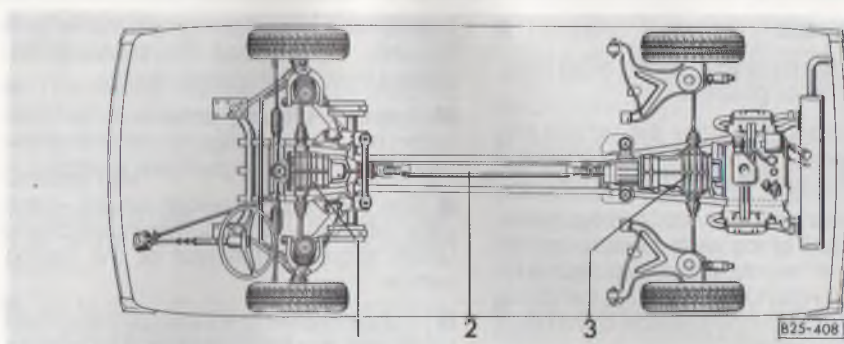

1 – Front axle final drive and viscous coupling

2 – Propshaft

3 – Rear axle final drive

This ingenious drive concept makes the Volkswagen Transporter/Caravelle syncro a versatile, efficient road vehicle which proves itself on ice and snow and under off-road conditions.

Further instructions are to be found on the following pages.

The vehicle can also be equipped with an anti-locking brake system (ABS)*.

Further details of the ABS are given on pages 26 and 37.

Attention

Although the four wheel drive and the ABS are very effective, the driving style must always be adapted to the road condition and traffic situation. Particularly on slippery roads the ABS cannot overcome the physical limits. The extra safety provided must not tempt one into taking unnecessary risks.

Advantages of four-wheel drive

The special drive concept of the Volkswagen Transporter/Caravelle syncro, when compared with a vehicle which only has a two-wheel drive, has advantages in respect of the following points:

The traction

The traction is increased considerably by the permanently engaged four-wheel drive. This is of particular benefit on snow and ice, when moving off and when driving on difficult mountain roads.

Driving in such conditions is less hazardous with the Volkswagen Transporter/Caravelle syncro:

There is no longer any need to drive past obstacles at speed on slippery uphill stretches, because one is afraid of becoming stuck. One can approach slowly, stop and then start off again.

The acceleration

As the driving force to be put onto the road goes to four wheels instead of two, the amount of slip is considerably reduced. This improves the adhesion between tyre and road surface and thereby, the acceleration capabilities on slippery road surfaces.

The handling

Decisive for the handling – particularly on slippery roads – is the grip between the four wheels and the road surface.

On two-wheel drive vehicles the driving wheels can spin on slippery surfaces if too much acceleration is given. This is detrimental to the adhesion.

By distributing the driving forces to four wheels instead of two the lateral forces which can be transmitted are increased on the Volkswagen Transporter/Caravelle syncro. The vehicle is less likely to break away.

Using winter tyres

Because of the four-wheel drive the Volkswagen Transporter/Caravelle syncro has good traction in winter road conditions even with the standard tyres. However the use of winter or all-weather tyres is recommended on all four wheels to obtain even better handling and braking.

For cross country driving the traction can be improved considerably with winter tyres.

Further instructions on the use of winter tyres are to be found on page 102.

Using snow chains

Snow chains not only improve the traction under winter road conditions but also braking. For this reason snow chains must also be used on vehicles with four wheel drive when snow chains are obligatory. Further details about using snow chains are given on page 102.

Operation

Contrary to customary four-wheel drives, the driver of a Volkswagen Transporter/Caravelle syncro does not need to engage or disengage the drive. The distribution of the driving force to the front and rear axles takes place automatically, and it is always matched to the existing road surface conditions.

Incorrect operation is thus excluded and the driver can concentrate fully on the traffic.

Only the differential locks* have to be engaged by hand under special operating conditions. Further details are given on the next two pages.

DRIVING TIPS

Driving on dry roads

The **differential locks must not be engaged**. They do not provide any advantages at all on dry road surfaces, but impair the vehicle's steerability.

Attention

Particularly if the front axle differential lock is engaged, the vehicle is no longer steerable.

Important instructions on the differential locks are to be found on page 29.

Driving on wet, slippery roads

Due to the four-wheel drive, the engine power is transferred even to a relatively smooth road surface.

On wet surfaces

On wet roads one should also note that even with the Transporter/Caravelle syncro it is possible for the front wheels to aquaplane at high speeds.

Attention

For this reason, one should avoid excessive speed and drive at a speed compatible with the road conditions.

The **differential locks*** must **not** be engaged.

Important instructions on the differential locks are to be found on page 29.

On slippery surfaces

On slippery surfaces the rear axle differential lock may only be engaged when moving off, and at very low speed. The lock should then be disengaged again. **The front axle differential lock must not be engaged.**

Important instructions on the differential locks are to be found on page 29.

Attention

The style of driving must always be adapted to suit the road surface and traffic conditions. The increased safety offered by this type of vehicle must not encourage one to take unnecessary risks.

In particular, one must always remember that the stopping ability is limited by the adhesion of the tyres on the road surface. The braking capability of the vehicle is the same as that of a normal two-wheel drive vehicle. For this reason, one should never be tempted by the good acceleration capabilities, even on slippery road surfaces, into driving too fast.

Driving cross country

Before driving for the first time over difficult terrain, it is advisable to make yourself familiar with the vehicle on normal roads, and also under easier off-road conditions. For safe driving cross country, the following rules are of great importance.

- Always wear your seat belt.
- Timely gear changing is better for the engine and prevents the vehicle from bogging down.
- Never drive with the clutch slipping as this leads to premature wear.
- The more uneven and creviced the terrain, the lower the speed must be. Pay attention to the vehicle's ground clearance.
- Do not drive over small embankments or declines at excessive speed. This can lead to bouncing during which it would be impossible to avoid any obstacle which may suddenly appear. In addition it could lead to vehicle damage.
- Drive down gradients in the same gear as you would drive up.

Change down to a lower gear in good time, to take full advantage of the engine braking effect – **do not** "coast" down with the clutch disengaged.

■ Embankments, gradients and similar obstacles should only be driven up or down at right angles, i. e. directly in line with the slope.

■ If however one is forced to drive across a slope and the vehicle tends to tip, one should immediately steer directly into the slope.

■ Before driving through water, determine the depth – the **permissible wading depth** (see Technical data) **must not be exceeded**.

■ **After driving through water or mud** the following points are important:

- Disengage differential locks*
- Clean excess dirt from engine compartment and underside of vehicle so that all moving and electrical and/or electronic parts can function properly.
- Clean tyres and wheels roughly and examine tyres for foreign bodies in the treads, and damage.
- Clean turn signals, lights and the number plate.

– Dry the brakes by driving a short distance with the brake pedal depressed. This will prevent brakes from pulling to one side or the braking effect being retarded.

– After going through **deep water**, pull dipstick out and check if there are drops of water present or if the oil level has risen. If this is the case the oil must be changed without delay.

■ **After driving through mud** the brakes must be checked and if dirty, cleaned (if necessary, the brake drums must be removed). This will prevent damage and premature wear to the brake system.

■ If, during **cross country** driving the vehicle sank deeply into soft ground or bottomed on an obstacle, the running gear, brake hoses and engine sump must be checked for damage.

Note

To prevent damage to the underside of the vehicle, the vehicle is equipped with protective plates in front of the front axle and underneath the engine and gearbox and protective rails running along both sides of the propshaft.

Note for vehicles with differential lock(s)

Before driving through a difficult cross country stretch (e.g. mud, sand, water, snow or steep gradients) it is advisable to engage the differential lock(s)* at low speed.

Attention

Important instructions regarding the differential locks are to be found on pages 29 and 30.



Intake air preheating valve (carburetor engines only)

To prevent the engine from drawing in water through the intake air preheater and being damaged when wading, there is a valve in the engine compartment on the right behind the maintenance flap with which the intake air preheating can be closed. The valve is closed by pressing it down and turning it to the right.

Other points to note: Changing wheels/tyres

On the Transporter/Caravelle syncro all four wheels must always have the same roll circumference. Further details are given on page 101.

Output testing

If the Transporter/Caravelle syncro is to be output tested on a dynamometer, the propshaft must be removed.

Brake test stand

For brake testing e.g. at MOT, the propshaft must be removed. The differential locks must not be engaged.

FILLING TANK

The filler neck is on the right hand side of the vehicle.

Key A = see page 7 – fits the lockable tank cap* (on vehicles with four wheel drive an extra key is supplied).

The fuel tank capacity is approx. 60 litres (syncro: 70).

Trouble-free refueling calls for correct use of filler nozzle.

■ Insert the nozzle fully into the tank neck and do not tilt it.

On vehicles with a factory fitted catalyst it should be noted that the filler neck is smaller in diameter, and is closed with a spring-loaded flap below the filler opening. Filler nozzles for unleaded petrol are correspondingly smaller in diameter and open the flap when inserted into the filler neck. This is to ensure that only unleaded petrol can be put in the tank.

■ Do not try to fill the tank too quickly, otherwise the fuel will foam and this may cause the nozzle to switch off too soon.

Note on environmental protection

As soon as the correctly operated automatic nozzle switches off for the first time, the tank is full. Do not try to put more fuel in because then the expansion space in tank will be filled and the fuel can then overflow when it becomes warm.

OPERATING INSTRUCTIONS

FUEL

Petrol engines

**Vehicles with catalytic converter
64, 68 and 70 kW
fuel injection engines**

**Unleaded regular petrol RON¹⁾ not
lower than 91.**

***Only unleaded petrol may be used in
these vehicles.***

The use of leaded petrol is very detrimental to the functioning of the emission control system because the lead is deposited in the catalytic converter.

***Even one tankful of leaded petrol will
detract from the efficiency of the cata-
lytic converter.***

Although unleaded fuel may be used again afterwards the original efficiency of the catalytic converter is never fully attained.

On vehicles with Lambda probe²⁾ the mixture formation is also negatively affected.

**Vehicles without catalytic converter
44 and 57 kW carburetor engines**

**Unleaded or leaded regular petrol
RON¹⁾ not lower than 91.**

In the interests of our environment unleaded petrol should be used whenever possible.

If regular petrol with adequate anti-knock properties is not available, use premium petrol (unleaded or leaded) or a suitable mixture.

82 kW fuel injection engine.

**Unleaded or leaded premium petrol
RON¹⁾ not lower than 98.**

For the sake of our environment, unleaded petrol should be used where possible.

Note

Unleaded petrol must comply with DIN³⁾ 51607 and leaded petrol with DIN 51600.

Only good quality petrol containing additives should be used – see "Petrol additives" also.

Petrol additives

The quality of the fuel has a decisive influence upon the running behaviour, performance and service life of the engine. The additives which are mixed into the petrol are of particular significance. One is advised therefore only to use **good quality petrol containing additives.**

If such fuel is not available, or if engine troubles such as starting difficulties, stalling during idling, vibration and loss of power occur, the appropriate additives should be mixed with the petrol when filling up the tank. At temperatures between about 0 and 15 °C, these additives prevent possible icing up of the carburetor, have an anti-corrosion effect, clean the fuel system and prevent deposits building up in the engine.

Additives which have been tested for Volkswagen engines are available from V.A.G. Dealerships in the Federal Republic of Germany and in many export countries. The V.A.G. Dealers are also informed with regard to the use of additives, and they know what to do in cases where deposits have already built up.

1) Research Octane Number, indicates anti-knock properties of the petrol.

3) Standards issued by the German Standards

2) Lambda = Air/petrol ratio.

Diesel engines

Diesel fuel to DIN 51 601

CN¹⁾ not lower than 45

Driving in winter

When using summer Diesel trouble may be experienced at temperatures below 0° C because the fuel thickens due to wax separation.

For this reason, winter Diesel which is more resistant to cold is sold during the winter in the Federal Republic of Germany, and this works satisfactorily down to between -15° and -22° C, depending on the make of fuel used.

In countries with different climatic conditions the Diesel fuels offered have a different temperature behaviour. Check with V A G Dealerships or filling stations in the country concerned regarding the availability of Diesel fuels.

Filter preheater

The vehicle is fitted with a filter preheater. This will ensure that the fuel system remains operational down to about -25° C provided that winter diesel which is cold resistant down to -15° C is used.

Dilution with petrol under these conditions is then no longer necessary.

If, at temperatures below -25° C the fuel is waxed to such an extent that the engine will not start it is sufficient to place the vehicle in a warm room for a while.

Fuel additives (anti-waxing agents and similar fluids) must not be mixed with the Diesel fuel.

¹⁾ Cetane Number, indicates the ignitability of Diesel.

OPERATING INSTRUCTIONS

What to do when wrong fuel has been put into tank

Premium petrol instead of regular

Regular petrol engines can be run on premium fuel with no problems. A worthwhile reduction of fuel consumption or an increase in output should however not be expected.

Regular petrol instead of premium

In isolated cases the premium petrol engines can also be run on regular petrol, but the octane rating must not be under 91 RON. The vehicle must then only be driven at medium engine speeds and low engine loading. **High engine loading with full throttle or high engine revs can cause engine damage.** Fill the tank with 98 RON premium petrol as soon as possible.

Premium petrol with RON 95 instead of petrol with 98 RON

The engines designed for premium 98 RON petrol can also be run as an exception on 95 RON premium petrol. However the style of driving must be adapted to the lower anti-knock properties of this petrol – see previous paragraph.

Leaded petrol instead of 95 RON

Vehicles with a catalytic converter must not be driven on leaded petrol because the function of the emission control system is adversely affected – see also page 76.

The fuel system must be emptied, in accordance with environmental regulations – preferably by a V.A.G Dealership.

Petrol instead of Diesel

The engine can be run on a concentration of up to approx. 30 % leaded or 95 RON regular petrol, or in an emergency, premium petrol with a maximum 95 RON.

However if too much petrol or even 98 RON premium petrol has been put in the tank accidentally, the engine must not be run otherwise damage will occur.

The fuel system must be drained – preferably by a V.A.G Dealership – bearing in mind environmental protection regulations and topped up again with Diesel until the concentration of petrol drops below 30 %.

Diesel instead of petrol

Petrol engines must not be run on Diesel. The fuel system must be emptied bearing in mind the environmental protection regulations – preferably by a V.A.G Dealership.

VEHICLE CARE

Regular and careful care helps to maintain the value of the vehicle.

Furthermore it can be one of the stipulations for the upholding of warranty claims should corrosion damage and paint defects occur.

Every V.A.G. Dealership carries stocks of suitable car care materials. The instructions for use on the container should be followed.

Attention

- **If misused, car care materials can be injurious to health.**
- **Car care materials must always be stored in a safe place where children in particular cannot reach them.**

Washing

The best protection against environmental influences is frequent washing and waxing. After the period when salt is put on the roads, the underside of the vehicle should always be washed thoroughly.

When the vehicle is washed in an automatic wash plant nothing need be noted apart from the usual precautions. It is however advisable to fold the outside mirrors inwards.

The longer salt, road dust, industrial grime, insects and bird droppings etc. are left on the paintwork the more damage they are liable to do to the finish.

When the load compartment has been cleaned, the sliding door hinges or the drop-side hinges must be regreased.

When vehicle is washed with a hose, do not point the jet of water directly at the lock cylinders – otherwise they will freeze up in winter.

Tar spots, traces of oil, industrial grime, insects, etc. cannot always be removed by washing. As they damage the paint if left on too long they should be removed as soon as possible with a suitable preparation.

In the interests of the environment the vehicle should only be washed in specially provided wash bays or in wash plants. In some districts, washing cars elsewhere may even be forbidden.

Waxing

The vehicle should be waxed as often as possible, either simply with a waxing shampoo or by applying a coat of wax. This will prevent dirt from sticking to the paint and industrial grime, tree resin or bird droppings from damaging the paint surface.

Polishing

Should only be done if paint has lost its shine and the gloss cannot be brought back with wax. If the polish used does not contain preservative compounds, the paint must be waxed afterwards.

Matt painted and plastic parts should not be treated with polish.

OPERATING INSTRUCTIONS

Touching up paint damage

Small marks in the paint such as scratches or stone damage should be touched up immediately with paint (Volkswagen touch-up brushes or spray cans) **before** the metal starts to rust.

However, should rust be found at any time it must be removed completely and then the area must be treated, first with an anti-corrosion primer and then the correct paint must be applied.

You can of course have this work done at a V.A.G Dealership.

The number of the original vehicle paint is given on the data sticker (see page 146).

Windows

Remove snow and ice from windows and mirrors with a plastic scraper only. To avoid scratches due to dirt on the glass, the scraper should only be pushed in one direction and not moved to and fro.

Traces of rubber, oil, grease or silicone can be removed with window cleaner or a silicone remover.

The windows should also be cleaned on the inside at regular intervals.

Do not dry the windows with the leather used for the paintwork, because traces of paint cleaner will cause streaks to appear on the glass.

To avoid damaging the **heating element wires** in the rear window, do not put stickers over the wires on the inside.

Door, lid and window weatherstrips

The weatherstrips will remain flexible and last longer if they are rubbed lightly with a rubber protective compound from time to time. This will also stop the weatherstrips freezing on in the winter.

Cleaning and lubricating sliding roof runners

To ensure that the sliding roof* continues to operate satisfactorily, it is advisable to clean the runners from time to time, at least once a year, and then to spray them with a silicone lubricant.

Cleaning plastic

Exterior plastic parts are cleaned with normal washing and interior parts with a damp cloth. If this is not sufficient, plastic parts and leatherette may only be cleaned with **special solvent-free** plastic cleaners.

Cleaning cloth upholstery

Upholstery cloth and similar materials must be cleaned with special cleaners or dry foam and a soft brush.

Cleaning and care of leather upholstery

A damp cloth is normally all that is required to clean leather covered steering wheels and seats etc.

For a more thorough cleaning job, it is best to use a sponge moistened with a lukewarm solution of a very mild detergent.

Do not wet the leather too much otherwise the water may seep through the stitching.

After cleaning, wipe dry with a soft cloth.

If necessary the leather can be treated with a suitable leather care product. On no account should cleaners or sprays containing solvents be used – these could attack the colouring of the material.

Care of chromed parts

Remove spots and marks with a chrome cleaner. A chrome protective compound can be applied to give long-term protection. Ensure that the chromed parts are covered completely and uniformly with the compound.

Cleaning seat belts

Keep the belts clean because they may not retract properly if very dirty.

Dirty belts can be cleaned by washing with a mild soap solution, without taking the belts out of the vehicle.

Attention

Do not have the belts cleaned chemically because the cleaning compounds damage the webbing material. Ensure that the belts do not come into contact with corrosive fluids.

Inertia reel belts should be completely dry before they are allowed to roll up.

Steel wheels

The wheels and the wheel trims should be cleaned thoroughly at regular intervals when the vehicle is being washed. This will prevent brake dust, dirt and road salt from accumulating on the wheel. Persistent, ingrained brake dust can be removed with an industrial grime remover. Paint damage should be repaired before rust can form.

Alloy wheels

In order to maintain the smart appearance of alloy wheels for a long period, regular care is necessary.

In particular, salt and brake pad dust must be washed off thoroughly at least every two weeks otherwise the surface of the alloy will be damaged. After being washed, the wheels should be treated with an acid-free cleaner for alloy wheels. About every three months it is necessary to give the wheels a good rubbing with hard wax. Paint polish or other abrasive solutions must not be used.

If the protective paint coat has been damaged, e.g. by stone impact, the damaged spots should be dealt with as soon as possible.

OPERATING INSTRUCTIONS

Cleaning and anti-corrosion treatment of engine compartment

Attention

Before working in the engine compartment, attention must be given to the instructions on page 84.

Good corrosion protection is very important, particularly in winter when the vehicle is frequently driven on salted roads.

The complete engine compartment should therefore be thoroughly cleaned, before and after the salting period, and then given anti-corrosion treatment so that the salt cannot have a damaging effect.

V.A.G Dealerships have stocks of the cleaning and preservation solutions recommended by the factory for this purpose, and they have the equipment necessary to apply them.

The ignition should always be switched off before the engine is washed.

Undercoating

The underside of the vehicle is coated with a special compound to protect it from chemical and mechanical influences.

However, as this protective layer becomes damaged when the vehicle is in use, the coating under the body and on the running gear should be examined at certain intervals – preferably before and after the winter season – and any damage made good.

V.A.G Dealerships have stocks of the correct compound, have the necessary equipment and are familiar with the application procedure. We advise you therefore to have the patching up or additional coating done by a V.A.G Dealership.

Note for vehicles with a catalytic converter

Due to the high temperatures which occur in the afterburning process, additional heat shields are fitted over the catalytic converter. Underbody sealant must not be applied to these shields, the catalytic converter, or the exhaust pipes.

Cavity preservation

All cavities where there is a risk of corrosion are permanently protected during production.

The preservation needs neither checking nor touching up. If a small amount of wax runs out of the cavities during high ambient temperatures, it can be removed with a plastic scraper and white spirit – *whilst doing this note the safety and environmental regulations.*

MAINTENANCE

As the vehicle is fitted with modern low maintenance technical components only a small amount of regular servicing is required in order to maintain the roadworthiness, economy and reliability.

The high manufacturing quality and the selection of high-class materials have made it possible to dispense with a special service immediately after the running-in period. On vehicles with a Diesel engine a First Service must be carried out after 1000 km.

The Inspection Service offered by the V.A.G Dealerships takes into account, to a large extent, the individual annual mileage covered and thus helps to keep the costs as low as possible. An **Inspection Service** is required every **12 months** or every **30 000 km**, whichever comes first.

If a mileage of 15 000 km (petrol engines) or 7 500 km (Diesel engines) is reached before 12 months has elapsed, a **Lubrication Service** must be carried out. See page 88 also, and the Service Schedule.

The Service Schedule also shows what work is required at the Inspection and Lubrication Services.

Under arduous operating conditions, e.g. extremely low ambient temperatures, very dusty conditions, building site work, etc. certain service operations should be carried out between the intervals given.

This applies in particular to:

- Changing the engine oil
- Cleaning or changing the air cleaner element
- Draining water from, or renewing the fuel filter on the Diesel engine.
- Lubricating the hinges of sliding and Double Cab doors, dropsides, locker lid and rear doors.

The service operations should be carried out in a V.A.G Dealership because this work requires special knowledge, workshop appliances and special tools. Furthermore this work must be done in accordance with our instructions.

Complete proof of servicing by a V.A.G Dealership can be one of the stipulations for the upholding of any warranty claims submitted during the one year warranty period.

Attention

Safety regulations and anti-pollution laws place very strict limits on the amount of repairs and adjustments to engine and running gear parts which can be done by the owner. By tinkering with parts which affect the safety of the vehicle one can endanger oneself and other road users.

In addition, the environment is burdened unnecessarily because by altering the settings of the carburetor, the fuel injection system or the ignition, the permitted emission values deteriorate and the fuel consumption increases.

The disposal of old oil, used brake fluid, dirty coolant, old batteries or worn-out tyres etc. must be done according to environmental protection regulations.

OPERATING INSTRUCTIONS

ENGINE COMPARTMENT COVER

The engine compartment cover is in the luggage compartment. This cover can be opened if both catches are rotated anti-clockwise.

On the dropside vehicle the engine compartment cover is a hinged lid in the rear cross panel.

ENGINE COMPARTMENT

Attention!

Particular care should be taken when working in the engine compartment!

■ **Switch off engine, remove ignition key.**

■ **Pull handbrake on firmly.**

■ **Move gear lever into neutral, or driving range selector lever into P.**

■ **Allow engine to cool off.**

■ **As long as the engine is at operating temperature, do not open the radiator cap because the cooling system is under pressure.**

■ **Avoid causing short circuits in the electrical system – particularly at the battery.**

■ **If tests have to be carried out with the engine running, there is an additional danger present from rotating parts – e.g. vee belts, generator etc. – and from the high voltage ignition system.**

Attention must be paid to the warnings given in this instruction manual and to the generally applicable safety regulations.

■ **When topping up fluids one should ensure that they are not mistaken, or for the other, under any circumstances, otherwise serious functional defects will result.**

ENGINE OIL

Viscosity and specification

A special, high quality multigrade oil is put in the engine at the factory and this can be used all the year round – except in very cold climates.

As a good engine oil is a prerequisite for trouble free operation and long engine service life, only a correspondingly high quality oil may be used for topping up and at oil changes.

The specifications shown on this page must be marked either separately or together with other specifications, on the containers.

When topping-up, the oils can be mixed with one another.

The **viscosity class** of the oil must be selected in accordance with the illustration. If the ambient temperature exceeds the given range briefly, the oil does not need to be changed.

Important note

Quite naturally engine oils are also being continually developed. For this reason the statements in this Instruction Manual are only in line with the current state at the time of going to press.

V.A.G Dealerships are kept up-to-date by the factory regarding changes. For this reason therefore the oil change should preferably be completed in a V.A.G Dealership.

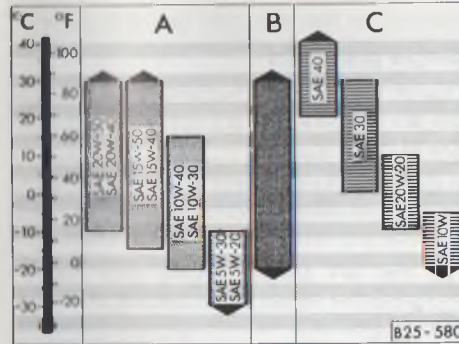

Petrol engines

- A – Multigrade oils, specification VW 501 01
 - Multigrade branded oils, specification API-SF or SG¹)
- B – Improved lubricity engine oils, specification VW 500 00
- C – Single grade branded oils, specification API-SF or SG¹)

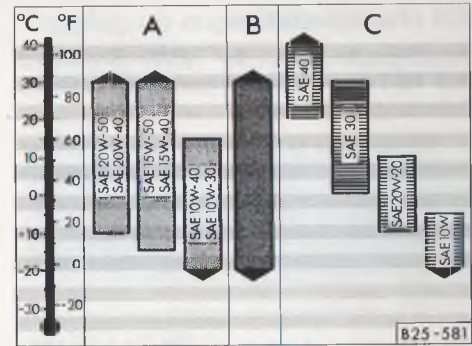

Diesel engine

- A – Multigrade oils, specification VW 505 00 (suitable for **all** Diesel engines, without exception)
 - Multigrade branded oils, specification API-CD (for topping-up in emergencies only).
- B – Improved lubricity engine oils, specification VW 500 00 (not for Turbo Diesel)
- C – Single grade oils, specification API-CD only (for topping-up in emergencies only).

www.vwT25camper.info - a useful website for owners and enthusiasts of VW T25 / T3 / Vanagon Campervans

¹) These oils may only be used if the approved engine oils are not available

OPERATING INSTRUCTIONS

Oil characteristics

Multigrade oils to VW Standard 50 101 are reasonably priced oils with the following properties:

- All year round use in temperate climate areas.
- Excellent cleaning ability.
- Efficient lubrication at all engine temperatures and load conditions.
- High resistance to ageing.

The improved lubricity oils as per VW Standard 500 00 have in addition the following advantages:

- All year round use at practically all temperatures.
- Low frictional losses in engine.
- Best possible starting even at very low temperatures.

Single grade oils

Due to their limited viscosity ranges these oils are not generally acceptable for all year round use.

In the case of petrol and turbocharged Diesel engines these oils should **only** be used in an emergency – see previous page.

For the NA Diesel engine (not turbocharged) this oil can be economical, in the case of high annual mileage and provided that oil changes are carried out frequently.

When using SAE 10 W single grade oil or SAE 5 W-20 or SAE 5 W-30 multi-grade oils, continuous high engine speeds and engine loading should be avoided.

This restriction does not apply when using improved lubricity oils.



Checking oil level

Every engine uses a certain amount of oil. The **oil consumption** can be up to 1.5 litres per 1000 km.

The engine oil level must therefore be checked at regular intervals, preferably when filling the tank. **Under arduous operating conditions or when engine is working hard it should be checked daily, before moving off.**

The dipstick and filler pipe can be reached through a flap behind the rear number plate. The dipstick location is shown in the illustration.

Checking the oil level or topping-up the engine oil is easier if the maintenance flap is held wide open. To do this, the oil filler cap can be jammed between the flap and the body when the flap is wide open.

The vehicle must be on a level surface when checking oil level. After stopping engine wait a few minutes for the oil to drain back to the sump.

Then pull the dipstick out, wipe it with a clean cloth and insert again. Then pull dipstick out again and check the oil level:

The level must be between the two marks.

The difference in quantity between the min. and max. marks is 1.0 litre.

When the engine is working hard such as in sustained high-speed motorway cruising in summer, when towing a trailer or when climbing mountain passes, the oil level should be kept up to the max. mark.

Topping-up engine oil

Unscrew the cap from the oil filler and pull extension pipe out fully.

Add oil.

Attention

When topping-up, no oil should be allowed to drip onto hot engine components – danger of fire.

Push extension pipe in again and screw the cap back on tightly.

Check the level with the dipstick.

The oil level must not be above the max. mark.

If it is, oil can be sucked out via the crankcase breather and pass out into the atmosphere via the exhaust system. On vehicles which are fitted with a catalytic converter, the oil can burn in the converter causing it to become damaged.

Carefully close the oil filler cap and push the dipstick in as far as it will go.

Otherwise oil could leak out when the engine is running.

OPERATING INSTRUCTIONS

Changing engine oil

The engine oil deteriorates not only due to use when engine is running but also due to ageing. The engine oil changing times depend therefore on the mileage and also the time elapsed.

Petrol engines

Engine oil change every 15 000 km or every 12 months (whichever comes first).

Diesel engines

Engine oil change every 7500 km or every 12 months (whichever comes first).

For further details, see Service Schedule.

For petrol and Diesel engines

If the vehicle is used continuously in arduous conditions, the engine oil must be changed at shorter intervals – see page 87 also.

Recommended oils and viscosity classes – see page 85.

Attention!

Until it can be disposed of in the prescribed manner, old oil must be stored out of the reach of children.

On no account may oil be poured down drains or onto the ground. Due to the problems of disposal, the requirement for special tools and the necessary expert knowledge, the engine oil and filter changes should best be carried out in a V.A.G Dealership.

Engine oil additives

No additives should be mixed with the engine oil.

Any damage caused by the use of such additives will not be covered by the warranty.

GEARBOX OIL

Specifications

Manual gearbox and final drive

- Gear oil, API-GL 4, SAE 80 or, Gear oil G 50, SAE 75 W 90

Front axle differential (syncro)

- Gear oil, API-GL 5, SAE 90

Automatic gearbox

- Final drive: Gear oil, API-GL 5, SAE 90
- Gearbox part: ATF Dexron®

Checking oil level

With the manual gearbox/final drive and front axle differential (syncro) the oil level does not need checking.

With the automatic gearbox the oil level in the final drive also does not need checking.

The ATF level in gearbox part must however be checked in between the intervals given in Service Schedule.

To do this the vehicle must be standing on a level surface. The level must only be checked when the ATF is **warm** (about 10 km after starting from cold the ATF is at the



correct temperature). If fluid is cold or too hot the reading will be incorrect. The engine must be running at idling speed, the hand-brake must be applied and the selector lever at "P".

To check, pull dipstick (see Fig.) out, wipe with a clean lint-free rag and then insert it fully again.

Pull dipstick out and check ATF level. When the ATF is warm **the level must be between the two marks** – otherwise the vehicle must be taken to a V.A.G Dealership without delay so that they can find the reason for the incorrect level. It is not sufficient to merely top up or drain off ATF.

Changing oil

With the manual gearbox/final drive and front axle differential (syncro) the oil does not need changing.

With the automatic gearbox the oil in the final drive also does not need changing. The ATF in gearbox part must however be changed at the intervals given in Service Schedule.

Due to the special tools required, the job knowledge necessary and the disposal problems, this should preferably be done by a V.A.G Dealer.

Notes

- **When there is no lubricant in the manual or automatic gearbox the engine must not be started and the vehicle may only be towed with driving wheels lifted.**

- **No additives should be mixed into the lubricants.**

OPERATING INSTRUCTIONS

POWER ASSISTED STEERING*



The power assisted steering is filled with hydraulic fluid-ATF-Dexron®

The reservoir is in the engine compartment on the right behind the maintenance flap.

To ensure satisfactory operation of the system it is essential that the fluid level in reservoir is correct.

The check must only be done with the engine running and the wheels in a straight-ahead position.

The fluid should always be between the "max" and "min" marks. When the level has dropped down to the MIN mark the power assisted steering should be checked at a V.A.G Dealership. It is not sufficient merely to top up with hydraulic oil. To do this, remove the red cap in the top of the reservoir.

Note

If the power assisted steering fails at a time, or when engine is not running (vehicle on tow) the vehicle can still be steered but more force will be required to turn the steering wheel.

COOLING SYSTEM

Under normal circumstances the cooling system is almost maintenance-free.

The cooling system is filled at the factory with a permanent coolant which is not changed.

The coolant consists of water and a 40 % concentration of our coolant additive G 11 (anti-freeze on glycol basis with anti-corrosion additives). This mixture not only gives the necessary frost protection down to -25 °C but also protects the entire cooling system against corrosion. In addition it prevents scaling and raises the boiling point of the coolant.

The concentration of the coolant therefore must not be reduced in the summer or in warm countries by topping up with plain water. **The coolant additive proportion must be at least 40 %.**

If greater protection against frost is required, the proportion of G 11 additive can be increased, but only up to 60 % otherwise the anti-freeze protection is reduced and furthermore the cooling effect is impaired.

Vehicles for export to cold countries usually have frost protection down to -35 °C.

Only our **G 11** or an additive with the **specification TL-VW 774 A** (marked on container) should be added to the coolant. These additives can be obtained from V.A.G Dealerships.

Other additives can be very detrimental to the anti-corrosion effect in particular.

Coolant losses

Coolant loss normally indicates leakage in the system. In this case the cooling system should be checked by a V.A.G Dealership without delay. It is not sufficient to merely add coolant.

In a water-tight system losses can only occur if the boiling point of the coolant is exceeded as a result of overheating. If this has not been caused by improper driving (see remarks on next page) or by restriction of the cooling air flow (radiator muff, additional lights in front of the radiator grille) a V.A.G Dealership should be contacted.

Overheating can occur if:

- the flow of cooling air is reduced, e. g. by a radiator muff, very dirty radiator fins (leaves, dust, insects) or additional driving lights in front of the radiator grille
- the boiling point of the coolant has been lowered by an incorrect mixture – see next column "Topping up coolant".
- the radiator fan is not working – see "Fan" on next page or
- the vehicle is driven up a long hill in too low a gear with the engine speed very high and at very high ambient temperatures – see „Fan" on next page.

If the cause of the overheating cannot be found and eliminated, contact a V.A.G Dealership as soon as possible otherwise serious damage may be done to the engine.

OPERATING INSTRUCTIONS



Reservoir

Checking coolant level

The correct coolant level is essential to the satisfactory operation of cooling system

For this reason, the coolant level should be checked regularly, and this is best done when refueling.

In the engine compartment there is a reservoir and an expansion tank.

The coolant level is normally only checked in the reservoir. It only needs checking in the expansion tank if a large amount of coolant has been lost or if the warning lamp for coolant temperature/coolant level lights up.

The level can only be checked properly when engine is not running



Expansion tank – Petrol engines

Open flap behind number plate. The level should be between min. and max. marks when engine is cold or just above the max. mark when engine is warm.

Topping up coolant

Topping up is normally done in the reservoir only.

Do not fill above the max. mark.

The excess coolant will be forced out of the system when engine becomes hot.

If the coolant warning lamp comes on the expansion tank must also be checked and filled to brim if necessary.



Expansion tank – Diesel engine

First switch the engine off and let it cool down, then cover cap with a cloth and turn cap one quarter turn to the left and let pressure escape first. Then take cap off.

Attention

Do not remove cap when engine hot.

Danger of scalding.

System is under pressure.

If, in an emergency only water can be added, the correct mixture concentration must be restored with the specified coolant additive (see page 91) as soon as possible.

www.vw125camper.info - a useful website for owners and enthusiasts of VW T25 / T3 / Vanagon Campervans

To avoid damaging the engine, add cold coolant only when engine is cold if a lot of coolant has been lost.

After topping-up, screw cap on again tightly.

The system must then be bled with the engine running (at a fast idle). Take the air intake grille off (see page 112), open the vent screw at the top of the radiator and set the heater lever to „warm“. As soon as coolant emerges, close the vent screw. Top level up in reservoir and expansion tank.

Attention

The coolant additive and the coolant are a danger to health.

The additive must therefore only be stored in the original container out of reach of children. If the coolant has to be drained at any time, it must be caught and also stored in a safe place until it is reused.

If the coolant is not to be used again it must be disposed of in accordance with environmental protection regulations.

Fan

The radiator fan is electrically driven and controlled by a thermo switch which is actuated by the coolant temperature.

After the engine is switched off, the fan can continue to run for a while (up to approx. 10 minutes) – even with the ignition switched off. It can also switch on again suddenly after a short time has elapsed if the coolant temperature rises due to accumulation of heat.

Notes

■ If the fan is not running although the coolant temperature is very high, the fuse should be checked and renewed if necessary – see page 111.

■ The speed of the fan does not depend on engine speed. The cooling effect cannot therefore be increased by changing down.

As long as the engine runs smoothly and a gradient can be taken without a large drop in speed it is not necessary to change down.

Driving in winter

In order to ensure that the frost protection is adequate, the concentration of the coolant should be checked before the cold season begins and, if necessary, corrected.

OPERATING INSTRUCTIONS

BRAKE FLUID



Brake fluid reservoir

The fluid reservoir is in the dash under the dash cover panel. The panel can be lifted to fill the reservoir. To do this grip in the recess at the back of the cover. When installing insert the lower front edge first.

Checking fluid level

The correct fluid level is essential to the satisfactory operation of the brake system. The fluid level must always be between the "max" and "min" marks.

The level of fluid tends to sink slightly when the vehicle is used due to the automatic adjustment for brake lining wear. This is quite normal.

However, if the level sinks noticeably in a short time, or drops below the "min" mark, the system may be leaking. Take the vehicle to a V.A.G Dealership at once and have the brake system checked.

The failure of a brake circuit is indicated by the brake warning lamp* lighting up (see page 37 also). When this happens take the vehicle to a V.A.G Dealership immediately and have the brake system checked.

Renewing brake fluid

Brake fluid absorbs moisture. In the course of time it takes up water from the ambient air. In time, an excess of water in the brake fluid can cause corrosion damage in the system. Furthermore the boiling point of the brake fluid is reduced considerably.

Attention

This can then cause the formation of bubbles in the fluid when the brakes are used hard. The efficiency of the brakes and thus the vehicle safety is then seriously affected.

For this reason the brake fluid must be renewed every two years.

Only use our genuine brake fluid (specification to US standards FMVSS 116 DOT 4). The fluid must be new.

Attention

Brake fluid is poisonous.

It must therefore only be stored in the closed original container out of reach of children.

Environmental protection regulations must be observed when disposing of the fluid.

Brake fluid will also damage paintwork and the plastic material of which the dash is made. Take great care not to spill any fluid when topping up the reservoir. Cover any round reservoir if necessary.

V.A.G Dealerships have all the necessary information and stock the specified brake fluid.

Renewal of the fluid should therefore be carried out by a V.A.G Dealership, preferably during an Inspection Service.

BATTERY



On vehicles with a petrol engine the battery is under the right hand seat. It can be reached when seat is pushed fully forward.

On vehicles with a Diesel engine the battery is on the right hand side of the engine compartment.

On vehicles with swivelling seats the seat must be turned 180° and pushed fully forward.

2nd Battery*

The 2nd battery is under the left hand seat. Access is gained by sliding the seat forwards as far as possible.

On vehicles equipped with ABS the 2nd battery is at the rear left hand side, inside the vehicle.

The 2nd battery supplies power for additional fitments when the vehicle and engine are stationary. A cut-off relay between the 1st and 2nd batteries prevents the 1st battery from being run down as well. This ensures that there is always sufficient power available for starting. When the vehicle is on the move, the 2nd battery is charged up together with the 1st one.

Checking acid level

Under normal operating conditions the battery requires hardly any maintenance. At high ambient temperatures however it is advisable to check the acid level at regular intervals. It should always be between the min. and max. marks on the side of the battery.

Attention

Battery acid is corrosive and must not get into the eyes or on to skin and clothes.

Any acid splashes must be washed off thoroughly with water. See a doctor if necessary.

The level should therefore preferably be topped up in a V.A.G Dealership.

Winter driving

Winter weather is particularly hard on the battery. Furthermore at low temperatures it has only a part of the capacity it has at normal temperatures. We recommend therefore that the battery should be checked preferably in a V.A.G Dealership before the onset of cold weather and charged if necessary. At the same time, the terminals will be cleaned and special grease applied. This will not only result in quicker, more reliable starting but will help to prolong the life of the battery.

If the vehicle is not driven for several weeks when temperatures are very low, the battery should be taken out and stored in a frost-free room, so that it does not freeze up and become damaged.

Store the battery out of reach of children.

To take battery out, first disconnect the two cables (see "Battery charging – Quick charging") and then remove retainer.

OPERATING INSTRUCTIONS

Charging battery

When charging with a low current (e.g. with a small charger) the connecting cables need normally not be taken off. The instructions from the charger manufacturer must however be noted.

Before **Quick charging**, that is charging with a high current, both connecting cables must be disconnected:

Disconnect minus cable first, then the plus cable.

A discharged battery can freeze at -10°C . It is essential to thaw out a frozen battery before it is given a quick charge otherwise it may explode!

The mains cable of the charger should not be connected until after the clips of the charger have been properly secured to the battery terminals:

Red = plus (or positive)

Black = minus (or negative)

When connecting the battery to the vehicle system again note:

Connect plus cable first, then the minus cable.

Attention

■ **The connecting cables must on no account be interchanged – this can cause the wiring to burn out.**

The gas given off during the charging process is highly inflammable so keep sources of ignition (naked flames, burning cigarettes etc.) well away from the battery.

■ **Never short the battery terminals (e.g. with a tool) as this causes the battery to heat up very quickly and it may burst.**

■ **To prevent any possibility of short circuiting, detach the battery earth cable before doing any work on the electrical system. When changing a bulb, it is sufficient to switch the lamp concerned off.**

■ **When the battery is disconnected, the engine must not be run, as this will damage the electrical system (electronic components).**

Starting by connecting an additional battery is described in the Do-it-yourself section.

Renewing a battery

If the battery has to be renewed at any time the new battery must have the same capacity, current strength and shape.

V.A.G. Dealerships have a range of suitable batteries and they can dispose of the old battery in accordance with environmental protection regulations. Batteries contain, amongst other things, sulphuric acid and lead, and must on no account be put with normal household waste.

WINDSCREEN WASHER SYSTEM



The filler opening of the container is under the carpet on left hand side of front footwell (left hand Fig.). The container holds about 3.5 litres. On vehicles with a headlight washer the capacity is 6.5 litres.

On vehicles with rear window washer* there is an additional container on the right in the luggage compartment (centre Fig.). This container holds about 1 litre.



To fill container

Lift carpet, open the flap and unscrew cap. Fill the container to top with water and screw the cap on again. Switch the ignition on and check that washer is working.

It is advisable to add a window cleaning solution (with anti-freeze additive in winter) to the water because plain water is not usually sufficient to clean the glass and headlight lenses quickly and thoroughly.

Note

If at any time no window cleaning solution with anti-freeze additive is available, methylated spirits can be used.

Do not, under any circumstances, add engine cooling system fluid or other additives.



Adjusting washer jets

When the vehicle is stationary, the water should hit the windscreen as illustrated.

The water jet for the rear window should hit the window in the centre of the wiped area.

The jets can be adjusted with a needle.

The jets for the headlight washer system* can only be adjusted with a special tool. When adjustment is necessary, contact your V.A.G Dealership.

OPERATING INSTRUCTIONS

Windscreen wiper blades

Good wiper blades are essential for clear vision.

To prevent streaks from forming on the glass the wiper blades should be cleaned regularly with a window cleaning solution. When very dirty and full of insect remains, the blades can be cleaned with a sponge or brush.

For safety reasons the wiper blades should be renewed once or twice a year. Wiper blades can be obtained from all V.A.G Dealerships.



Changing wiper blades

Taking wiper blade off

- Hinge wiper arm up and position blade horizontally.
- Press retaining spring (arrow A) and push blade towards screen at the same time (arrow B).

Securing wiper blade

The retaining spring must engage audibly in the wiper arm.

WHEELS

General notes

- New tyres do not give maximum grip straight away and should therefore be run in at moderate speeds and a careful style of driving for about the first 100 km. This will help to make the tyres last longer.
 - Check tyres for damage from time to time (cuts, splits, cracks and lumps) and remove any foreign bodies embedded in the treads.
 - To avoid damage to tyres and wheels drive over curbs and similar obstacles very slowly and as nearly at right angles as possible.
- Damage to wheels and tyres is not always easy to see, so if you think that a wheel is damaged, it must be checked by a V.A.G Dealership.
- Keep grease, oil and fuel off the tyres.
 - Replace missing dust caps as soon as possible.
 - Mark wheels before taking them off so that they rotate in the same direction when put back on again.
 - When taken off, the tyres should be stored in a cool, dry and preferably dark place. Tyres which are not on wheels should be stored in a vertical position.

One should also note that tyres age even if they are not being used. Tyres which are older than 6 years should **only** be used in an emergency combined with a particularly careful style of driving.

The age of the tyre can be seen in the lettering on the tyre wall – see page 101.

Tyre life

Tyre life depends to a considerable extent on the following factors

Inflation pressures

The inflation pressures should therefore be checked twice a month and always before a long trip, not forgetting the spare wheel.

Always check the pressures when the tyres are cold. **When warm, the pressure is higher but do not reduce.** The pressures are given on page 137 and on a sticker on the left hand door pillar between the hinges.

Pressures which are too high or too low shorten tyre life quite apart from the detrimental influence on vehicle handling.

Attention

At continuous high speeds a tyre in which the pressure is too low flexes more and heats up excessively. This can cause tread separation and tyre blow out.

In addition low tyre pressures increase the fuel consumption.

Mode of driving

Fast cornering, hard acceleration and violent braking also increase tyre wear.

Balancing wheels

The front wheels on new vehicles are balanced. However, when vehicle is running various influences can cause the wheel to become unbalanced and this causes steering vibration.

As imbalance also increases steering, suspension and tyre wear the wheels should be balanced again. Furthermore a wheel should always be rebalanced when the tyre has been repaired or when a new tyre has been fitted.

OPERATING INSTRUCTIONS

Incorrect wheel alignment

Incorrect wheel alignment not only causes excessive, usually uneven tyre wear but it can also impair the car's safe handling. If unusual tyre wear is noticed, contact a V.A.G. Dealership.

Wear indicators

At the bottom of the tread of the original tyres there are 1.6 mm high "wear indicators" running across the tread – see Fig. There are 6–8 of these indicators – according to make – evenly spaced round the tyre circumference. Marks on the flanks of the tyre (for example the letters "TWI" or triangles) show the locations of the wear indicators.

At the latest, the tyre should be renewed when there is no longer any tread at these points.

When tread depth is down to 1 mm – measured in the tread groove next to the wear indicator bar – the official permissible minimum tread depth has been reached (in export countries this figure may differ).



Attention

As worn tyres cannot grip the road surface properly when driving at high speeds on wet roads, and the vehicle tends to aquaplane sooner, we strongly recommend that the tyres are renewed when there is still 3 mm tread depth remaining.

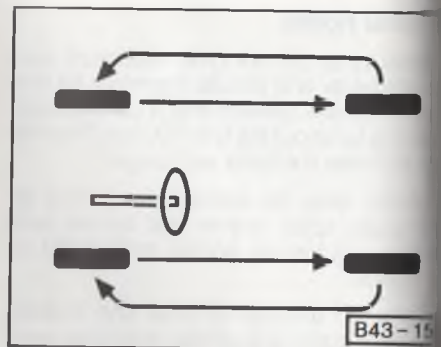

Changing wheels round

If the tyres are wearing unevenly, it is advisable to change them round as shown. If the tyres will then last for about the same mileage.

When the wheels have been changed round it may be necessary to have the front wheels balanced again.

Renewing wheels/tyres

Wheels and tyres are important design features. The wheels and tyres approved by us are specially matched to the model concerned and contribute largely to the excellent roadholding and safe driving characteristics.

■ Fitting and repairing tyres requires expert knowledge and special tools. This work may only be carried out by specialist personnel.

V.A.G Dealerships have the necessary expert knowledge, the tools required and the necessary facilities for disposing of old tyres in the correct manner. Furthermore, many V.A.G. Dealerships stock an attractive range of tyres and wheels.

■ For safety reasons the tyres should be renewed in pairs and not singly. The tyres with the deepest tread should always be on the front wheels.

■ Only radial ply tyres of the same type, size and the same tread pattern may be combined.

On the Transporter/Caravelle syncro the following must also be noted:

All four wheels must always be fitted with tyres of the same size, type, tread pattern and make so that the viscous coupling does not engage the front axle drive unnecessarily because of speed differences between the two axles. If the front wheels have a noticeably smaller roll circumference than the rear wheels so that they turn faster, wind-up will occur in the transmission and cause the tyres to wear quicker.

■ Never fit used tyres where their previous history is not known.

■ Knowing the tyre lettering and its meaning makes the selection of the correct tyres easier. Radial ply tyres have the following lettering:

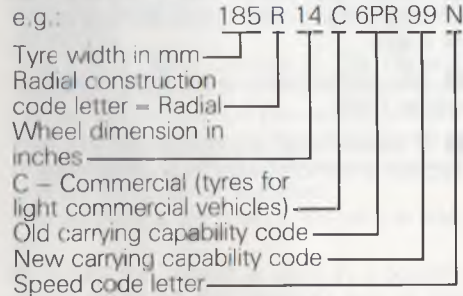

The manufacturing date is also to be seen on the tyre wall.

DOT . . . 129 . . . means that the tyre was produced in the 12th week of 1989.

Tyres which are older than 6 years of age should only be used in an emergency and then with a particularly careful style of driving.

Attention

If you wish to fit your car with non-standard wheels or tyres please note:

■ For technical reasons it is not possible in every case to use wheels from other vehicles – in certain conditions not even wheels from the same vehicle model.

A V.A.G Dealership should also be asked about the technical possibilities regarding the fitting of steel wheels in place of alloy wheels, or vice versa.

OPERATING INSTRUCTIONS

■ **Wheels and wheel bolts are matched to one another.**

On changing to a different type of wheel (e.g. alloy wheels or wheels with winter tyres) the correct bolt, or nut, with the proper length and conical shape must be used. The security of the wheels and the functioning of the brake system depend on this.

■ **Using types of wheel and/or tyre which have not been approved by us for your vehicle model can be detrimental to the safety of the vehicle. It can also affect the vehicle under the construction and use regulations.**

■ **If wheel trim discs or a front spoiler are subsequently installed, ensure that the air flow remains adequate to cool brakes.**

V.A.G Dealerships are fully informed about the possible conversions of tyres, wheels and wheel trims.

Winter tyres

In winter conditions the vehicle handling, including four wheel drive vehicles, can be improved by winter tyres.

When fitting winter tyres, note the following:

■ Only radial ply winter tyres should be used. The factory recommended tyre sizes are given on page 136.

■ With winter tyres, the PR figures on the sidewalls should also be noted. The tyres must not be below the specified carcass strength.

■ To obtain the best possible handling characteristics, winter tyres must be fitted on all four wheels.

■ Winter tyres are no longer fully effective when the tread has worn down to a depth of 4 mm.

■ All-weather tyres can be used instead of winter tyres.

■ If winter tyres are obligatory, this also applies to vehicles with four wheel drive.

Snow chains

Snow chains may be used on all the tyre sizes listed on page 136. On vehicles with rear wheel drive the chains may be fitted on the rear wheels only. Only thin chains which do not stand clear more than 15 mm (including tensioner) should be used.

When driving over roads which are free of snow the chains must be removed. On such roads they are detrimental to vehicle handling, damage the tyres and wear out quickly.

In the Federal Republic of Germany the maximum permissible speed with snow chains is 50 km/h.

The following should also be noted on Transporter/Caravelle syncro vehicles:

Snow chains should, where possible, be fitted on all four wheels. If only two chains are available they must be fitted on the rear wheels.

On vehicles with 16 inch wheels, snow chains may only be fitted on the rear wheels.

No snow chains may be fitted onto 5 1/2 x 16 wheels which have 6.50 R 16 tyres on. If necessary, one must convert to a smaller sized wheel – see "Wheels" on page 136.

Further details about using snow chains are given on page 71.

ARDUOUS OPERATING CONDITIONS

The vehicle construction and equipment is designed for normal operating conditions. This also applies to the frequency and the extent of the maintenance laid down in the Service Schedule.

If the vehicle is used under arduous operating conditions (e.g. continuous trailer towing, exceptionally high or low ambient temperatures, very dusty conditions, poor quality fuel, etc.) it may be necessary to carry out special technical preparations, such as using oil of the appropriate viscosity, installing special air cleaners (cyclone filters), modifying the ignition timing etc. Furthermore the maintenance must also be matched to the operating conditions – see page 83 also.

Driving abroad

If the vehicle is to be taken abroad, the following must also be borne in mind:

■ If the vehicle has a catalytic converter, one must ensure that unleaded petrol will be available during the journey – see page 76. The automobile clubs offer information about the unleaded filling station network.

■ In many countries there is a large network of V.A.G Dealerships where your vehicle can be serviced. Despite this there are certain countries in which there is only a limited amount of V.A.G service or even none at all.

■ In certain countries it is also possible that your vehicle model is not sold so that certain spare parts are not available for your vehicle or that the V.A.G personnel are not familiar with the repair procedure should anything go wrong.

The V.A.G Sales Centres in the Federal Republic of Germany or the Importer concerned will be only too pleased to give advice on the necessary technical preparation of the vehicle, on the maintenance required and on the repair possibilities.

The addresses are given in the vehicle wallet.

■ When the vehicle is used in a country which drives on the opposite side of the road to the home country, the wedge shaped areas on the headlight lenses must be masked – see page 116.

Driving on holiday

Before starting off note the following points:

■ The roadworthiness and driving safety are particularly important when on holiday see page 64.

■ With a fully loaded vehicle and/or roof rack, the handling changes. The driving style must be adapted to the changed conditions – more information on loading is given on page 138.

The tyre pressure must be checked.

■ If a trailer is to be towed, there are many special points to note – see page 67.

■ If an oil change or an Inspection Service is probably going to become necessary during the trip, it is advisable to have this work done before going on holiday if possible.

OPERATING INSTRUCTIONS

DRIVING IN WINTER

In winter the following points should be noted:

■ Winter weather is particularly hard on the battery and it should therefore be checked before the onset of cold weather, preferably by a V.A.G Dealer – see page 95.

If the vehicle is not driven for several weeks when the temperatures are very low, the battery should be taken out – see page 95.

■ On vehicles with a Diesel engine, winter Diesel must be used at temperatures below 0° C – see page 77.

■ The water should be drained out of the Diesel fuel filter before the onset of winter. This operation is also included in the Lubrication Service.

■ The anti-freeze in the cooling system should be checked before the cold season starts.

■ The engine oil viscosity must be correct for the ambient temperature – see page 85.

■ Particularly in winter, frequent washing and waxing of the vehicle is the best way to protect it against damage from environmental influences.

■ The windscreen washer system should always be filled with a window cleaning solution with anti-freeze additive in the winter.

■ To remove snow and ice from the windows and mirrors, a plastic scraper should be used – see page 80.

■ Even on vehicles with four wheel drive the roadholding and handling can be improved in winter road conditions by the use of winter or All-weather tyres – see pages 102 and 136.

■ When driving in mountainous districts it is advisable to take snow chains with you in the winter. On some such roads, snow chains are obligatory – and this applies also to four wheel drive vehicles – see page 102 also.

ACCESSORIES, MODIFICATIONS AND RENEWAL OF PARTS

All Volkswagen Transporter/Caravelle Model versions delivered from the factory offer a high degree of active and passive safety. To ensure that this remains so, the vehicle must not be modified without due consideration.

If your Volkswagen Transporter/Caravelle is to be fitted with accessories subsequently, is to be technically modified or parts have to be renewed later on, the following points must be noted:

■ **Before** buying accessories and **before** making technical modifications a V.A.G Dealer for Volkswagen Commercial vehicles should be consulted because the close cooperation with us makes the V.A.G Organization fully competent in such matters.

Attention

■ **In your own interests we recommend that only expressly approved V.A.G accessories and Genuine Volkswagen Parts are used on your Volkswagen Transporter/Caravelle. The reliability, safety and suitability of these accessories and these parts has been specially determined for the Volkswagen Transporter/Caravelle. Despite continuous market observation we cannot assess or accept responsibility for other products even though in some cases approval has been granted, or an official permit has been issued.**

■ Approved V.A.G accessories and Genuine Volkswagen Parts can be obtained from V.A.G Dealerships for Volkswagen Commercial vehicles and they will of course carry out the fitting correctly.

■ If technical modifications are to be made, our guidelines must be observed. This is to ensure that no damage occurs to the vehicle, the traffic and operating safety is retained and that the modifications are permissible. V.A.G Dealerships for Volkswagen Commercial vehicles will also carry out this work correctly or will recommend a specialist workshop.

DO-IT-YOURSELF

FIRST AID KIT, WARNING TRIANGLE

The **First Aid kit and warning triangle** can be stowed, depending upon the vehicle version, either under the left hand front seat or under the rear seat bench.

Note

The First Aid kit and warning triangle are **not** part of vehicle equipment.

TOOLS, JACK

The **jack and tools** are located under the left hand seat. They can be taken out when the seat is pushed fully forward and the cover underneath lifted up.

On vehicles with a second battery or a swivelling seat, the tools and jack are located either behind the left hand seat or under the rear seat, depending on arrangement of seats in the passenger compartment. The trim under the rear seat can be pulled out to the front.

The screwdriver blade is reversible.

Attention

■ The jack supplied by the factory is only designed to lift your vehicle model. On no account should heavier vehicles or other loads be lifted.

Never start up the engine, and engage a gear as long as a driving wheel is in contact with the ground – danger of accident.

■ If work has to be done underneath the vehicle, the vehicle should be supported on suitable stands.

SPARE WHEEL

Depending on the vehicle version, the spare wheel will be secured either:

- in a pan underneath the vehicle floor at the front, or
- standing up in the rear of the luggage compartment, or
- on a pivoting spare wheel carrier on the rear of the vehicle.
- in the case of some dropside versions, in a locker underneath the loading area.



To take out the **wheel under body**, remove the bolt with the wheel nut spanner and pull the hook away.

Attention

**Keep clear as the pan falls down.
Danger of injury.**

Then pull the wheel forward off the pan.

Note

On vehicles with a front spoiler it may be necessary to take the weight off the front of vehicle before removing the spare wheel. If necessary the front can be lifted slightly with the jack or the spoiler taken off.



To stow the spare wheel, place it on the pan with offset downwards and swing the pan up until the hook engages. Then insert the bolt and tighten it.

Attention

For safety reasons the pan must always be bolted in position so that it cannot release accidentally.



The spare wheel in luggage compartment is bolted to the left side panel. To remove the wheel, take the bolt out by hand.

Attention

For safety reasons the spare wheel must always be bolted securely to the side panel when vehicle is moving.

The spare wheel on the back of the vehicle is secured to a swivel-type bracket. This bracket can for example, be swung round to the side, through approx. 90° to enable the tailgate to be opened. To do this, lift the securing hook underneath the wheel and pull the latch grip to the rear with a sharp jerk. The bracket also latches in the fully open position.

To swing the spare wheel bracket towards the vehicle again, first release the bolt on the lower hinge. Then swing the bracket round towards the tailgate and press the latch grip in firmly until the securing hook engages.

Attention

For safety reasons the spare wheel bracket must always be against back of the vehicle, and properly secured in this position, when the vehicle is on the move.

To take the wheel off, remove the protective boot and then the securing nuts.

To secure the spare wheel to the bracket, mount the wheel on the bracket, outside first, and firmly tighten the securing nuts. Finally replace the protective boot.

Attention

For safety reasons the spare wheel must always be properly secured when the vehicle is moving.

If the spare wheel is stowed in the locker underneath the pick-up loading surface it is accessible through the locker flap. It is securely bolted to the vehicle floor. After changing a wheel, the one no longer in use must be properly secured in the locker again.

CHANGING WHEELS

■ Park the vehicle as far as possible away from the traffic flow. If necessary switch on emergency warning lights and place the warning triangle in position – note legal requirements.

■ All vehicle occupants should leave the vehicle and move to a safe area (e.g. behind the barrier).

■ Apply handbrake firmly. If the vehicle is on a slope, place a stone or some similar object behind one of the wheels on the opposite side.

■ The wheel trim caps are removed with the bar and wire hook:

Place the hook in the two holes on the edge of cap, insert the bar through the hook and lever the cap off.

■ Loosen the wheel nuts/bolts with the box spanner and bar approximately one turn.

■ Insert the jack into the appropriate lifting socket (Fig.) as far as possible. If necessary, clean the socket beforehand. Place the jack vertically.

If the ground is soft, place a large strong piece of packing under the jack base plate.

■ Lift the vehicle until the wheel is clear of the ground.

■ Remove bolts, place them on a clean surface (hub cap, cloth, paper) next to the jack and take the wheel off.



B25-319

■ On vehicles with alloy wheels, change the wheel hub cap.

■ Fit spare wheel and tighten the bolts/nuts lightly at first. The bolts/nuts must be clean and easy to screw in – do not, under any circumstances, grease or oil the bolts/nuts.

Attention

To ensure that the wheel is secured properly the contact surfaces to the wheel hub or drum and for the wheel nuts/bolts must not be dirty or rusty.

■ Lower the vehicle to the ground and tighten the bolts/nuts in a diagonal sequence.

■ Install the trim cap.

Notes

■ Pay attention to the following after changing a wheel:

- Immediately check the tyre pressure of the spare wheel which has been fitted.
- Have the tightening torques of the wheel bolts/nuts checked with a torque wrench as soon as possible. The torque, for steel and alloy wheels, and for the temporary spare wheel is 180 Nm.

If it has been established when changing the wheel that wheel bolts/nuts are corroded and hard to screw in, they must be renewed before checking the tightening torque.

Until these points have been carried out one should, for safety reasons, only drive at a moderate speed.

Attention

If the vehicle is to be subsequently fitted with wheels or tyres which differ from those fitted by the factory, it is essential to read the remarks on page 102.

DO-IT-YOURSELF

FUSES

The individual current circuits are provided with fuses.

The fuse box is located on the left under the dash panel behind a cover.

It is always advisable to have a few spare fuses in the vehicle. These can be obtained from any V.A.G Dealership and can be inserted on the underside of the fuse box.

To take the cover off

Detach the cover at the front, swing it down and unhook it.

To put the cover back

Hook the cover into the eyes on the mounting for fuse box, swing it up and press into position.

Changing a fuse

- Switch off the component concerned.
- Using the list of fuses, find out which fuse belongs to the component that has failed.
- Pull out the blown fuse with the plastic clip (located on the cover in front of the fuse box).
- Replace the blown fuse – can be recognised by the burnt metal strip – with a fuse of the **same capacity**. Spare fuses can be inserted on the underside of the fuse box. These fuses can be obtained from a V.A.G Dealership.

Notes

- If the newly inserted fuse blows again after a short time, the electrical system must be checked by a V.A.G. Dealership as soon as possible.
- On no account should fuses be patched up because this can cause serious damage elsewhere in the electrical system.
- Some of the components listed are only found on certain models or are optional extras.

Fuse layout

(from left to right)

No.	Component	Amp.	No.	Component	Amp.
1.	Radiator fan	30	13	Fresh air blower	20
2	Brake lights	10	14	Rear window heating, electric mirror heating, lighting switch light	20
3	Reading lamps, interior lights, illuminated make-up mirror, clock, cigarette lighter, radio	15	15	Reversing lights	10
4	Emergency light system	15	16	Horn, dual tone horn	15
5	Vacant		17	Windscreen wiper motor	10
6	Fog lights	15	18	Brake warning lamp, heated driving seat, cruise control, belt warning system	10
7	Tail and side light left	10		with emergency horn	20
8	Tail and side light right	10	19	Turn signals	10
9	Headlight right	10	20	Number plate light, headlight washer	10
10	Headlight left	10	21	Low beam left	10
11	Windscreen wiper and washer switch	15	22	Low beam right	10
12	Additional heat exchanger, electric windows, cruise control electric outside mirror, auxiliary heater, A/C, rear window wiper	20			

Additional fuses in holders

■ under right rear seat:

Reading lamp, right rear	Amp. 8
Luggage compartment lights	8
Electrically adjustable seat right	16
Electrically adjustable seat left	16

■ Above fuse box:

Instrument lighting	10
Rear fog light	10
Overheating fuse for auxiliary heater	10
Main fuse for auxiliary heater	20
Emergency horn	15
Central locking	20
Automatic fuse for electric windows	20
Rotating warning lamp	15

■ In engine compartment on left
in black box.Diesel glow plug system¹⁾ – 50

DO-IT-YOURSELF

CHANGING BULBS

Before starting to replace a bulb, switch off the light concerned.

Do not touch the glass part of the new bulb with bare fingers because the finger marks left on the glass evaporate when the bulb becomes hot, the vapour settles on the reflector and dims it.

Always use the same type of bulb. The designation is marked on the base of the bulb or on the bulb itself.

It is advisable to always carry a box of spare bulbs in the vehicle. This can be obtained from a V.A.G Dealership.

For safety reasons this box should contain the following bulbs:

- 12 V 60/55 W – Main headlight (H 4)
- 12 V 4 W – Side lights and number plate light
- 12 V 10 W – Taillight
- 12 V 21 W – Stoplight and turn signal



Headlight

To change a headlight bulb or side light bulb the headlight must be taken out:

Turn the 5 quick-release clips in the upper grille 90° with a screwdriver. Pull the grille forward slightly at the top and lift it out. Then remove screws (see fig.) and take the headlight out.



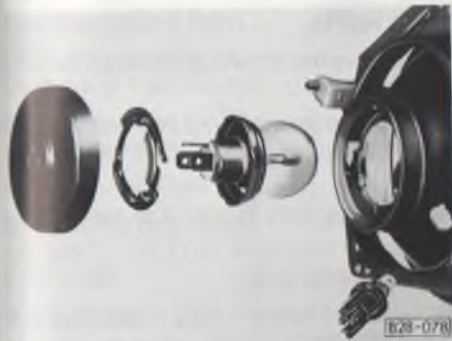

Normal headlight bulb*

Headlight bulb

(Normal and Halogen H 4)

- Pull connector off.
- Take cap off.
- Turn ring to left and take it off or squeeze spring clip of the bulb holder together and fold it clear.
- Take bulb out and insert new bulb so that the locating lug on the bulb plate engages in the recess in the reflector. The centre one of the three terminals on bulb base is then at the top.



H4 headlight bulb

- Install ring, press it against reflector and turn it to right as far as possible, or fold spring clip over bulb base. Squeeze the clip together and engage it in the retaining lugs.
- Press cap back on.
- Attach connector.
- Install headlight and air intake grille again.
- Have the headlight beam alignment checked.

Side light bulb

The side light bulbs are located in the headlight reflectors.

- Turn the bulb holder fully to the left and take it out of reflector.
- Press the defective bulb into the holder, turn it to the left and take it out.
- Insert the new bulb.
- Insert the bulb holder in the reflector and turn the holder fully to the right.

DO-IT-YOURSELF

Headlight bulb (H3)*

(Inner headlight on vehicles with dual headlights)

- Turn the cap to the left and take it off.
- Pull the wire connector off.
- Unhook the spring clip holding the bulb and swing it away.
- Take the bulb out and insert the new bulb so that the locating lug on the bulb plate engages in the recess in the reflector.
- Swing the spring clip over the bulb plate. Squeeze the clip together and engage it in the retaining lugs.
- Attach the wire again.
- Install the cap and turn it to right.
- Have the headlight setting checked.

Fog lights (H3)*

■ Remove the screw on the underside of the fog light.

- Take the insert out.
- Pull the wire for bulb out of the cable connector.
- Unhook the spring clip and fold it away.
- Take the bulb out. Insert the new bulb so that the locating lug on the reflector engages in the recess on the bulb plate.
- Swing the clip over the bulb plate. Squeeze the ends together and engage in the retaining lugs.
- Insert the bulb wire in the cable connector.
- Install the insert – upper side first – in the housing and secure with the screw.
- Have the light setting checked.

Rear lights

- Remove the screws and take off the lens and bulb holder.
- Squeeze the tabs together and take the holder out. (On some versions there is only one tab.)
- Press the bulb in, turn it to the left and take it out.
- Fit the new bulb.
- Install the holder – tabs must engage – and install the screws.

Front turn signals

- Take the lens off.
- Pull the rubber cap off.
- Press the tab on the bulb holder inward and take the holder out of the housing.
- Turn the bulb slightly to the left and re-new.
- Press the rubber cap on again carefully and install the lens.

Number plate light

The number plate lights are pushed into the cross panel from the rear.

- Press the lugs together and pull the light housing out to the rear.
- Remove the lens.
- Press the defective bulb into the holder, turn it to the left to remove it and then insert a new bulb.
- Install lens.

Ensure that the lug in the lens engages in the opening in the bulb-holder otherwise the number plate will not be illuminated properly.

- Do not overtighten the lens screws.
- Install the light again. Ensure that the housing fits over the metal tab at the top and engages in the hole in the cross panel at the front.

Interior light

- Press the retaining spring at the opposite end to the switch inwards and take the light out.
- Renew the bulb.
- Insert the light at switch end first.

Reading lamps*

- Lever the adjusting ring out at side recess with a flat screwdriver blade.
- Press the bulb into the fitting slightly, turn it to the right and take it out.
- Install the new bulb.
- Fit the adjusting ring so that the recesses in ring are in line with those on the lamp housing.
- Press the adjusting ring on.

Table light*

- Push the flat screwdriver blade behind the light housing on the left so that the spring behind it is pushed to one side and then lever the housing off.
- Pull the reflector out.
- Change the bulb.
- Insert the reflector again.
- Push the lug on the right of the lamp housing behind trim on the right first and then press the light on.

Interior light in front of the passenger seat, step light, luggage compartment lights.*

- Lever the glass out to the side with a flat screwdriver blade.
- Change the bulb.
- Press the glass into the trim again.

DO-IT-YOURSELF

ADJUSTING HEADLIGHTS



Correct headlight adjustment is very important for vehicle and traffic safety. The adjustment should therefore only be done with a special appliance.

On vehicles with headlight range control, the knurled wheel on the dash panel must be in the basic (—) position.

The headlights are adjusted from the front through the grille with a Phillips screwdriver.



The illustrations show the adjusting screws for the right headlight. The screws for the left headlight are symmetrically opposite.

A – Lateral setting

B – Vertical setting

Turning the screw to the right lowers the headlight beam.

MASKING HEADLIGHTS



When the vehicle is used in a country which drives on the opposite side of the road to the home country, the asymmetric headlights will dazzle oncoming traffic.

To prevent this, the wedge-shaped sector on the headlight lenses must be covered up with an opaque adhesive strip.

The illustration shows the strip installed for the change from right hand to left hand traffic.

INSTALLING A RADIO

When service installing a radio or replacing a set installed by the factory the following points should be noted:

■ The connection * already in the vehicle is for Genuine Volkswagen radios¹⁾ from model year 1988.

The supply plug has the following cable colours and connections:

Red	- Permanent positive (+)
Brown	- Negative (-) (vehicle earth)
Grey/Blue	- Instrument panel lighting
Blue/White *	- Speed signal for automatic volume control (GALA)

■ Radios with other connections must be connected with an adapter wire which can also be obtained from a V.A.G Dealership.

Attention

If the proper adapter wire is not used or wires are cut off and left without insulation, or connections become interchanged, there is a risk of short circuiting. This can cause the wiring to burn out.

■ It is advisable therefore to have the installation of the radio system done by a V.A.G Dealership. They are fully informed about the technical features of the vehicle, have the Genuine radios¹⁾, the necessary fitting parts from the Genuine Volkswagen Accessory Programme¹⁾ and work in accordance with the guidelines developed by the factory.

■ The radios from the Genuine Volkswagen Accessory Programme¹⁾ are similar to those used in the factory and ensure trouble-free installation. These sets also contain advanced technical details such as for example digital frequency indication, automatic station finding, computer controlled tuning, traffic news facility, speed dependent volume control *, anti-theft coding * and well-planned easy-to-operate design. In the Federal Republic of Germany there is also an Exchange Service for these radios so that even after years of use a set requiring repair can be exchanged cheaply for a completely reconditioned, good-as-new set by a V.A.G Dealership.

■ Loudspeakers, fitting parts, aerials and suppression kits should also be taken from the Genuine Volkswagen Accessory Programme¹⁾. These parts have all been specially developed for each vehicle model.

If other parts are used or parts from previous models there is a danger that operation will be faulty. Furthermore the use of non-approved suppression parts can affect the vehicle registration under the construction and use regulations.

■ When installing the aerial it is essential to ensure that the hole provided by the factory where the aerial enters the body is sealed very carefully. In addition the aerial cable, the connecting wires and the loudspeaker wires must be routed so that they cannot chafe, rattle or become tangled up with moving parts (e.g. pedals, steering, heating controls etc.). Otherwise the operation of the controls may be affected or vehicle safety impaired.

In cases of doubt, exact information can be obtained from V.A.G Dealerships.

DO-IT-YOURSELF

EMERGENCY STARTING

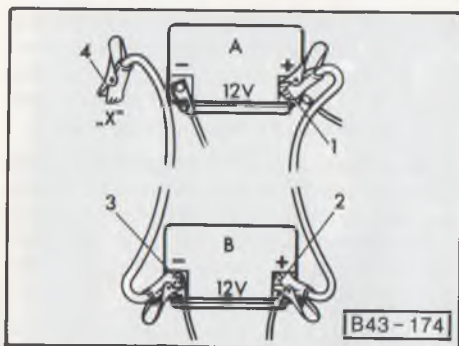

A – Flat battery

B – Boosting battery

The battery is under the right hand seat in the cab.

On vehicles with a Diesel engine it is in the engine compartment.

If the engine will not start because the battery is flat, **jumper cables** can be connected to the battery of another vehicle to start the engine. The following points should be noted:

■ Both batteries must be 12 Volt types. The capacity (Ah) of the boosting battery must not be a lot lower than that of the flat one.

■ Only use jumper cables with insulated clips.

■ The jumper cables must be heavy enough to carry the load. Note the cable manufacturer's data.

■ A flat battery can freeze at -10°C and if a battery is frozen it must be thawed out before connecting a jumper cable, otherwise it could explode.

■ There must be no contact between the vehicles, otherwise current can flow as soon as the plus terminals are connected.

■ The flat battery must be properly connected to the electrical system.

■ The engine of the boosting vehicle must be running.

■ Only connect jumper cables as follows:

1. One end of (+) cable (usually red) to the (+) terminal of flat battery.
2. Other end of red cable to (+) terminal of boosting battery.
3. One end of (-) cable (usually black) to (-) terminal of boosting battery.
4. Other end of black cable (x) to the bolt securing earth wire to body.

Do not connect the cable to the battery minus terminal. The sparks could ignite the explosive gas flowing out of the battery.

Att
Tak
non
cab
and
tou
par
■
the
rot
me
■
the
■
fla
av
da

Attention

Take great care to ensure that the noninsulated parts of the jumper cable clips do not touch one another and that the plus cable does not touch current conducting vehicle parts – short circuit danger.

■ Route the jumper cables so that they cannot come into contact with rotating parts in the engine compartment.

■ Do not stand with your face over the battery – danger of acid burns.

■ Keep ignition sources (naked flames, burning cigarettes etc.) well away from the battery – explosion danger!

■ Start the engine as described in the "Starting and Stopping Engine" section.

If the engine does not start straight away, stop trying after about 10 seconds, wait about half a minute and then try again.

■ When engine is running, disconnect cables in reverse sequence.

DO-IT-YOURSELF

TOW STARTING/TOWING

General remarks

■ Towing eyes are provided at the front and rear on the right underneath the bumpers.

Towropes or bars should be attached at these points only.

■ The towrope should be slightly elastic to reduce the risk of damage to both vehicles. It is advisable to use synthetic fibre ropes, or ropes of similar elastic material. **It is however safer to use a tow bar.**

Avoid excessive towing effort and do not jerk. During towing operations on other than surfaced roads there is always the danger that the attachment points will be overloaded and damaged.

■ **Before trying to start the engine by towing, the battery from another vehicle should be used for starting where possible** – see previous page.

If the vehicle has to be tow started or towed at any time, the following must be noted:

■ Traffic regulations regarding towing must be observed.

■ Both drivers must be familiar with towing procedures. Inexperienced drivers should not attempt to tow start or tow.

■ When using a towrope the driver of the towing vehicle must engage the clutch very gently when moving off and changing gear.

■ The driver of the vehicle being towed must ensure that the towrope is always taut.

■ The emergency lights must be switched on on both vehicles – unless local regulations differ.

■ Turn the ignition key to the "Drive" position so that the steering wheel is free and the turn signals, horn, and, if necessary, the windscreen wiper and washer can be used.

■ As the brake servo only works when the engine is running, more pressure is required on the brake pedal when the engine is not running.

■ On vehicles with power assisted steering more force is required to turn the steering wheel when engine is not running.

■ When there is no lubricant in the manual or automatic gearbox the vehicle may only be towed with the driving wheels lifted.

Tow starting

The following points must be noted when tow starting:

- Before moving off, engage 2nd or 3rd gear.
- Switch the ignition on.
- As soon as the engine starts, depress the clutch and move the gear lever into neutral to avoid running into the towing vehicle.
- **On vehicles with a catalytic converter the engine must not be started when catalytic converter is at operating temperature by towing the vehicle a long distance, otherwise unburnt petrol can enter the catalytic converter and be burned there.**
- **For technical reasons tow starting a vehicle with an automatic gearbox is not possible.**

Towing

When towing vehicles with an automatic gearbox, the following points must be noted in addition to the details on the previous page:

- Selector lever at "N".
- Do not have the vehicle towed faster than 30 mph (50 km/h).
- Do not tow further than 30 miles (50 kilometers).

If the vehicle has to be towed long distances it must be lifted at the rear.

Reason: When the engine is not running, the gearbox oil pump is not working and the gearbox is not adequately lubricated for high speeds or long distances.

The following should also be noted on four-wheel drive vehicles:

If the vehicle has to be towed with either front or rear axle lifted, one must ensure that the wheels on the raised axle are free to rotate. This may necessitate removing the propshaft. If this is not possible, the vehicle may only be moved with all four wheels on a recovery vehicle or a trailer.

DO-IT-YOURSELF

LIFTING THE VEHICLE

Vehicle hoist

Before driving over a vehicle hoist ensure that there is sufficient clearance between the hoist and low parts of the vehicle.

Trolley jack

The vehicle should only be lifted with a trolley jack at the points shown here.

To prevent damage to the underside of the vehicle, it is essential to use a suitable piece of rubber or wooden packing.

On no account should the vehicle be lifted under the engine sump, gearbox, rear axle or the front axle, as this can cause serious damage.

Attention

- Never start up the engine, and engage a gear as long as a driving wheel is in contact with the ground – danger of accident.
- If work has to be done underneath the vehicle, the vehicle should be supported on suitable stands.



Lifting points for hoist and trolley jack

The vehicle may only be lifted at the points shown here.

Front

Next to the front jacking point (left hand Fig.).



Rear

At rear cross member (right hand Fig.).

Vehicle jack

Lifting with the vehicle jack is described on pages 106 and 109.

ENGINE

Petrol engines

- 4 stroke petrol engine
- 4 cylinder Boxer
- Cast-iron cylinders
- 4 bearing crankshaft
- Light alloy cylinder heads
- Light alloy crankcase
- Valves operated via push rods and rocker arms
- Maintenance free valve gear with hydraulic tappets
- Cooling system filled for life
- Radiator with separate expansion tank
- Electric radiator fan controlled by thermo switch
- Low maintenance electronic ignition system
- Single or twin choke down-draft carburetor (44, 54 or 57 kW engines)

- Petrol injection system * with overrun fuel cut-off
- Emission control system *
- Thermostatically, controlled intake air preheating and electrical mixture preheating
- Dry air cleaner with paper element, cyclone filter for very dusty countries *
- Long life spark plugs
- Optical and acoustic oil pressure monitor *

Diesel engines

- Four stroke Diesel engine, installed longitudinally, inclined 50°
- 4 cylinders in line
- Cast iron block
- 5 bearing crankshaft
- Sheet metal sump
- Light alloy cylinder head
- Valves operated by overhead camshaft, toothed belt drive
- Liquid cooling
- Radiator with separate expansion tank
- Thermostatically controlled electric fan
- Mechanical fuel injection
- Distributor type injection pump with cold starting aid
- Exhaust turbocharger on 51 kW engine
- Preheated fuel filter *
- Diesel – self-bleeding fuel system
- Dry air cleaner with paper element

TECHNICAL DESCRIPTION

POWER TRANSMISSION

Manual gearbox

- Hydraulically operated single plate clutch
- Baulk synchronized four or five speed manual gearbox with final drive in one housing
- Filled for life
- Rear wheel drive

Transporter/Caravelle syncro

- Baulk synchronized 4-speed manual gearbox with additional cross country gear (4+G gearbox).
- Permanent four-wheel drive through viscous coupling
- Manually operated differential locks for front and/or rear final drives available as optional extra

Automatic gearbox*

- Hydro-dynamic torque converter and planetary gear train with three forward speeds and reverse
- Final drive flanged on
- Rear wheel drive
- Filled for life

STEERING

- Maintenance free rack and pinion steering with relay idler
- Safety steering column
- Power assisted steering*

AXLES

Front axle

■ Independent wheel suspension with wishbones/track control arms, coil springs and telescopic dampers

■ Anti-roll bar

Additional on Transporter/Caravelle syncro

■ Double jointed shafts

■ Differential lock*

■ Wear-free viscous coupling

Rear axle

■ Independent suspension with diagonal trailing arms, coil springs and telescopic dampers

■ Double jointed drive shafts

Additional on Transporter/Caravelle syncro

■ Differential lock*

BRAKES

■ Hydraulic dual circuit brakes

■ Disc brakes at front

■ Self-adjusting drums at rear with retardation-sensitive pressure regulator

■ Brake servo

■ Mechanical handbrake effective on rear wheels

Anti-locking brake system (ABS)*

BODY

■ Unitary body/chassis

■ Floor frame reinforced by side and cross members

TECHNICAL DESCRIPTION

EMISSION CONTROL SYSTEM *

The exhaust emission control system effectively reduces the amount of pollutants in the exhaust gas.

The main parts of the emission control system are

- A mixture formation system which guarantees very exact composition of the air/petrol mixture at all engine speeds
- the catalytic converter
- the Lambda probe¹⁾

The catalytic converter is installed in the exhaust pipe. It consists of a steel-cased ceramic body containing a multitude of longitudinal passages which are vapour coated with a thin layer of platinum or rhodium.

The exhaust gas flows through the catalytic converter and reacts with an afterburning process when it contacts the precious metal coating. In this process three pollutants (three-way catalytic converter) are converted to harmless substances as follows.

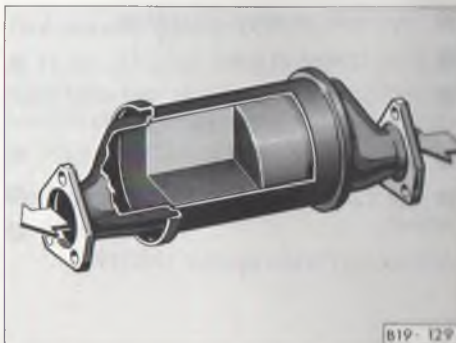

- Carbon monoxide to carbon dioxide
- Hydrocarbons to water
- Nitrogen oxide to nitrogen (four fifths of the air we breathe is nitrogen).

A stipulation for the proper functioning of the catalytic converter, however, is that the exhaust gas has a certain specific composition and minimum temperature when it enters the catalytic converter. To obtain this composition, exact regulation of the fuel/air mixture is required. A very exact regulation is obtained on vehicles which are fitted at the factory with a Lambda probe¹⁾.

The Lambda probe¹⁾* is fitted in the exhaust pipe where it measures the exhaust gas composition continuously. The information signal is fed to an electronic control unit which in turn regulates the mixture formation system so that the mixture is kept constantly correct.

The exhaust emission control system technology is so well developed that no additional maintenance whatsoever is required, it is absolutely imperative that the vehicle is **only** filled up with **unleaded fuel**.

Attention

Due to the high temperatures which can occur in the catalytic converter in very unfavourable conditions, the vehicle should not be parked so that the catalytic converter can come into contact with inflammable materials.

If whilst driving, the engine misfires, loses power and runs unevenly, this could be a fault in the ignition system.

PETROL VAPOUR ACCUMULATOR*

In a case like this, unburnt fuel can enter the exhaust system and then escape to atmosphere. Furthermore, the catalytic converter could become damaged due to overheating. The vehicle speed must be reduced immediately, and the defect should be eliminated at the nearest V.A.G Dealership.

Note

Even in the case of a perfectly working exhaust emission control system there can, under certain engine operating conditions, be a sulphur-type exhaust smell. This depends upon the sulphur content in the fuel being used. Quiet often this is remedied by selecting another brand of fuel or, filling up with unleaded premium petrol.

Vehicles with a regulated catalytic converter, in the Federal Republic of Germany and other export countries, have, depending upon version, a fuel system which incorporates an activated charcoal filter (petrol vapour accumulator).

This prevents the fuel vapour escaping into the atmosphere.

These vapours pass into a container filled with activated charcoal and, when the engine is stationary they are accumulated in the activated charcoal. When the engine is running, a valve opens, the container is ventilated and the fuel vapour is fed into the engine for combustion.

The system works completely automatically and is maintenance-free.

TECHNICAL DATA

Where not otherwise indicated or listed separately, all technical data is for standard vehicles with and without a catalytic converter in the Federal Republic of Germany.

For special vehicles and vehicles for other countries these figures may be different.

Please note that the details in the official vehicle documents can be taken as the correct figures.

The DIN figures are determined in accordance with the standards issued by the German Standards Institution.

ENGINE DATA

	Output ¹⁾ kW (bhp) at rpm	Maximum torque Nm at rpm	Number of cylinders	Cap- acity cm ³	Stroke mm	Bore mm	Com- pres- sion	Mixture formation	Fuel ²⁾
Petrol engines with catalytic converter (US Standard)	70 (95)/4800	160/2800	4	2109	76	94	9.0	Fuel injection	91 RON unleaded
	68 (92)/4500	154/2800	4	2109	76	94	9.0	Fuel injection	91 RON unleaded
Petrol engines without catalytic converter	44 (60)/3700	140/2200	4	1913	68.9	94	8.6	Carburetor	91 RON unleaded/leaded
	57 (78)/4400	153/2600	4	1913	68.9	94	8.6	Carburetor	91 RON unleaded/leaded
	82 (112)/4800	174/2800	4	2109	76	94	10.5	Fuel injection	98 RON unleaded/leaded
Diesel engines	37 (50)/4200	103/2000	4	1588	86.4	76.5	23.0	Fuel injection	Diesel
	42 (57)/4500	103/2800	4	1715	86.4	79.5	23.0	Fuel injection	Diesel
	51 (70)/4500	138/2500	4	1588	86.4	76.5	23.0	Fuel injection	Diesel

www.vwT25camper.info - a useful website for owners and enthusiasts of VW T25 / T3 / Vanagon Campervans

¹⁾ According to DIN or ECE regulations. Due to different methods of measuring, slight deviations are possible.

²⁾ For further details see pages 76 and 77.

FUEL CONSUMPTION

Passenger models

litres/100 km

The consumption figures were determined in accordance with DIN 70 030 Part 1 (July 1978 Edition). The figures in brackets were determined by a slightly different method of measuring (UTAC)

The basis for both consumption measurements is Recommendation A 70 of the EEC. The tests are carried out in three different conditions:

- The measurements for 90 km/h (56 mph) and
- 120 km/h¹⁾ (75 mph) are carried out at a constant test speed.
- For the urban measurement normal town driving is simulated.

Depending on driving style, road and traffic conditions, environmental influences and vehicle condition, the figures obtained in actual practice may differ from those given.

All figures were measured with standard tyres. On vehicles with other tyres the figures will vary accordingly.

To convert to mpg, divide 282.5 by the number of litres (DIN or UTAC).

Carburetor engines	44 kW 4 speed	5 speed	57 kW 4 speed	5 speed	Automatic	syncro 14 inch
Caravelle/Combi/Double cab 90 km/h 120 km/h ¹⁾ Urban	9.7 (10.5) 12.9 (12.9)	9.7 (10.8) 11.8 (11.9)	9.5 (9.7) 13.9 (12.8)	9.4 (9.5) 10.9 (13.9)	10.7 (11.2) 13.8 (12.6)	11.2 (10.6) 14.9 (12.8)
High-roofed Combi 90 km/h 120 km/h ¹⁾ Urban	11.5 (11.2) 12.9 (12.9)	11.0 (10.8) 11.8 (11.9)	10.5 (10.6) 13.9 (12.8)	10.3 (10.2) 10.9 (13.9)	12.2 (12.4) 13.8 (12.6)	12.3 (11.9) 14.9 (13.5)

www.vwT25camper.info - a useful website for owners and enthusiasts of VW T25 / T3 / Vanagon Campervans

1) Valid only for vehicles with a top speed of more than 130 km/h.

TECHNICAL DATA

Petrol injection engines

litres/100 km	70 kW 5 speed	Automatic	syncro 14 inch	68 kW 5 speed	82 kW 5 speed	Automatic	syncro 14 inch	syncro 16 inch
Caravelle/Combi/ Double cab								
90 km/h	9.8	12.5	12.1	1)	8.8 (9.4)	9.6 (10.3)	10.1 (10.4)	10.4
120 km/h	14.5	16.8	17.1		13.1 (12.9)	13.5 (14.8)	15.4 (15.7)	14.9
Urban	15.5	16.5	16.1		12.0 (12.3)	13.8 (14.0)	13.9 (12.4)	14.3
High-roofed Combi								
90 km/h	10.7	13.9	13.4	1)	9.8	11.1	10.8 (11.0)	11.1
120 km/h	15.8	18.4	—		14.3	15.1	16.2 (17.1)	15.8
Urban	15.5	16.5	16.1		12.0	13.8	13.9 (12.1)	14.3
Caravelle Carat								
90 km/h	10.0	13.2	—	1)	9.0 (9.4)	9.8 (10.5)	—	—
120 km/h	14.7	17.8	—		13.3 (13.0)	13.7 (14.9)	—	—
Urban	16.1	17.1	—		12.6 (12.6)	14.4 (14.4)	—	—

Diesel engines

litres/100 km	37 kW 4 speed	5 speed	42 kW 4 speed	5 speed	51 kW 4 speed	5 speed	syncro 14 inch	syncro 16 inch
Caravelle/Combi/ Double cab								
90 km/h	9.1 (9.0)	8.0 (7.7)	8.5	8.0	8.3 (7.6)	7.9 (7.5)	8.8 (8.7)	9.5
120 km/h	—	—	—	—	—	—	—	—
Urban	9.1 (9.0)	9.6 (10.1)	8.9	9.8	8.6 (8.0)	8.7 (5.7)	9.7 (8.1)	9.5
High-roofed Combi								
90 km/h	9.8 (9.7)	9.0 (8.7)	9.4	8.9	9.2 (8.2)	8.9 (8.1)	9.7 (9.4)	10.5
120 km/h	—	—	—	—	—	—	—	—
Urban	9.1 (9.0)	9.6 (10.1)	8.9	9.8	8.6 (8.0)	8.7 (6.7)	9.7 (8.1)	9.5

www.vwT25camper.info - a useful website for owners and enthusiasts of VW T25 / T3 / Vanagon Campervans

Commercial vehicles

litres/100 km

These consumption figures were determined in accordance with DIN 70030 Part 2 (July 1978 Edition) with half payload at a constant $\frac{3}{4}$ of top speed (but not more than 80 km/h) plus 10 %.

Depending on driving style, road and traffic conditions, environmental influences and vehicle condition, the figures obtained in actual practice may differ from those given in the standards.

All figures were measured with standard tyres. On vehicles with other tyres the figures will vary accordingly.

To convert to mpg, divide 282.5 by the number of litres.

Carburetor engines	44 kW		57 kW		Automatic	syncro 14 inch
	4 speed	5 speed	4 speed	5 speed		
Van	10.9	10.9	11.7	11.4	12.5	13.1
High roofed Van	11.7	11.2	12.1	12.5	13.4	13.5
Pick-up	11.7	11.7	12.3	11.9	12.9	13.7

Petrol injection engines	70 kW	Automatic	syncro	68 kW	82 kW	Automatic	syncro	syncro
	5 speed		14 inch	5 speed	5 speed		14 inch	16 inch
Van	13.1	15.1	15.2	1)	12.9	13.3	15.1	13.4
High roofed Van	13.9	16.5	15.9		13.6	14.5	15.7	13.9
Pick-up	13.6	15.9	15.5		13.3	13.9	15.4	13.7

Diesel engines	37 kW	5 speed	42 kW	5 speed	51 kW	5 speed	syncro	syncro
	4 speed		4 speed		4 speed		14 inch	16 inch
Van	8.3	7.6	8.8	8.1	8.6	9.1	9.9	10.0
High roofed Van	8.9	7.9	9.2	8.5	10.6	10.2	11.9	12.1
Pick-up	8.6	8.1	8.8	8.7	9.6	9.1	10.9	11.1

www.vwT25camper.info - a useful website for owners and enthusiasts of VW T25 / T3 / Vanagon Campervans

1) These figures were not available at the time of going to print.

TECHNICAL DATA

PERFORMANCE

Maximum speed

in km/h

The maximum speeds were measured without any equipment such as mud flaps which affect the performance.

All figures were measured with the standard tyres. On vehicles with other tyres the figures will vary accordingly.

Carburetor engines	44 kW		57 kW		Automatic gearbox		57 kW syncro	
	4 speed / 5 speed		4 speed / 5 speed				14 inch	
Caravelle, Combi, Van, Double Cab	118		130		125		125	
High roofed Van	113		125		120		120	
Pick-up, Large platform Pick-up	115		127		122		122	
Petrol injection engines	70 kW		70 kW syncro	68 kW	82 kW	82 kW syncro		syncro
	5 speed	Automatic	14 inch	5 speed	5 speed	Automatic	14 inch	16 inch
Caravelle, Combi, Van, Double Cab	141	136	135	138	150	146	142	140
Caravelle Carat	141	136	—	138	150	146	—	—
High roofed Van	136	131	130	133	145	141	137	135
Pick-up, Large platform Pick-up	138	133	132	135	147	143	139	137
Diesel engines	37 kW		42 kW		51 kW	51 kW	syncro	syncro
	4 speed	5 speed	4 speed/5 speed		4 speed	5 speed	14 inch	16 inch
Caravelle, Combi, Van, Double Cab	103	110	115		127	127	122	116
High roofed Van	103	105	110		122	122	117	111
Pick-up, Large platform Pick-up	103	107	112		124	124	119	113

HILL CLIMBING ABILITY

With full load on good roads driving nonstop in 1st gear.

Values in %, approx.

Carburetor engines	4 speed	5 speed	Automatic	syncro 14 inch	syncro 16 inch
44 kW	28	30	—	—	—
57 kW	30	33	46	54	—
Petrol injection engines					
68, 70 kW	—	38	50	61	—
82 kW	—	38	49	70	73
Diesel engines					
37 kW	26	26	—	—	—
42 kW	25	27	—	—	—
51 kW	33	32	—	58	63

TECHNICAL DATA

SPARK PLUGS

44-, 57- and 82-kW-engines

101 000 005 AB / W 7 DTC
101 000 001 AC / 14-7 DTU
101 000 007 AB / N 7 BYC

64-, 68- and 70-kW-engines

101 000 009 AA / W 7 CCO
101 000 012 AA / 14-7 CUO
101 000 011 AA / N 288

Notes

The spark plugs are renewed during the V.A.G Inspection Service.

If the spark plugs have to be renewed between the V.A.G Inspection Services, the following should be noted:

■ Engine, spark plugs and ignition system are matched to one another. To avoid faulty operation and even engine damage only the Genuine Volkswagen spark plugs for the engine concerned should be used. Important, among other things, are the number of electrodes and the heat value.

■ Since the plugs may be altered at short notice for technical reasons during the current model year, the plugs used can differ from those listed here. It is therefore advisable to obtain plugs only from V.A.G Dealerships – they have the latest information.

VEE BELTS

Petrol engines	Genuine Part. No.	Belt size
Crankshaft/coolant pump/alternator	025 903 137 A	9.5x1100 LA ¹⁾
Crankshaft/air conditioner compressor	025 260 849 B	12.5x1153 LA
Crankshaft/servo steering pump	025 903 137	9.5x1080
Diesel engines		
Crankshaft/coolant pump	068 121 039 B	9.5x 643 LA ¹⁾
Crankshaft/coolant pump (on power-assisted steering)	046 903 137	9.5x 900
Coolant pump/alternator (65 A)	068 903 137 C	9.5x 600 LA
Coolant pump/alternator (90 A)	068 121 039 G	9.5x 617
Crankshaft/air conditioner compressor	068 260 849 E	12.5x1225
Crankshaft/servo steering pump	068 145 271 C	9.5x 763

Note

The vee belts are among the most severely stressed parts of a vehicle. The belts must therefore be subjected to very high quality requirements.

When renewing a belt it is not sufficient to use just any belt of the same size. For safe operation, only the special Genuine Volkswagen belt for the vehicle concerned should be used. The correct belts can be obtained from V A G Dealerships under the Genuine Part number given.

Vee belts for certain components that are not very often fitted (e. g. a second generator) are not listed here. The Part Nos. for such belts can be obtained from V A G Dealerships.

¹⁾ The Vee belt is absolutely essential for the running of the engine. For this reason therefore, one is advised to carry a spare belt in reserve on the vehicle (see also "Operation" section, Generator warning lamp).

TECHNICAL DATA

WHEELS

	Tyres	on wheel	Winter tyres
Rear wheel drive	175 R 14 C 6 PR	5½ J × 14	175 R 14 C/ 185 R 14 C
	185 R 14 C 6 PR 99 N	5½ J × 14	185 R 14 C 6 PR 99/97 N on wheel 5½ J × 14
	205/70 R 14 97 R reinforced	5½ J × 14	
	185 R 14 C 6 PR 99 N	6 J × 14	
	205/70 R 14 97 R reinforced	6 J × 14	
Four wheel drive (4x4) 14 inch	185 R 14 C 6 PR 99 N	5½ J × 14	
	205/70 R 14 97 R reinforced	6 J × 14 or 5½ J × 14	
	205 R 14 C 6 PR 105 M	6 J × 14	205 R 14 C 6 PR/ 8 PR 109/107 N on wheel 5½ J × 14
16 inch	195 R 16 C 8 PR 107 N	5½ J × 16	195 R 16 C 8 PR on wheel 5½ J × 16
		5½ J × 16	6.50 R 16 10 PR ¹⁾ 108 N 205 R 16 reinforced 104 Q

The tyre/wheel combinations in the table are valid for steel and alloy wheels. Details of whether other tyres or wheels can be used can be obtained from V.A.G. Dealerships.

For winter tyres the most suitable tyre/wheel combination is given. The winter tyre recommendation applies also to All-weather tyres. Further remarks on the use of winter tyres are given on page 102.

Attention

If you wish to fit your vehicle with non-standard wheels or tyres, (e.g. alloy wheels or wheels with winter tyres) you must read the appropriate notes in the left hand and centre columns on page 101/102.

Snow chains may be used on all the summer and winter tyres listed (excl. 6.50 R 16) – see page 102 also.

Tyre pressures

Model	Tyres	Permissible axle loads		Tyre pressures (in bar)		
		Front in kg	Rear in kg	Front	Rear	Spare
Rear wheel drive						
Ambulance	185 R 14 C	1200	1200	2.5	2.5	2.5
		1200	1400	2.5	3.3	3.3
	205/70 R 14	1200	1200/1400	2.1	2.8	2.8
All other models	175 R 14 C	1100	1200	2.8	3.3	3.3
	185 R 14 C	1200/1300	1300/1400	3.0	3.7	3.7
	205/70 R 14	1200/1300	1300/1400	2.1/2.5	2.8	2.8
4 Wheel drive						
All models	185 R 14	1300	1380	3.0	3.3	3.3
	205/70 R 14	1300	1380	2.5	2.8	2.8
	205 R 14	1300	1380	2.5	3.0	3.0
	195 R 16	1300	1380	2.8	3.0	3.0
	205 R 16	1300	1380	1.8	2.1	2.1
	6.50 R 16	1300	1380	3.0	3.5	3.5
	195 R 16 M+S	1300	1380	3.0	3.5	3.5

These pressures are for cold tyres – the pressure is higher when tyres are warm but it must not be reduced.

The tyre pressures must be checked regularly. Correct pressures are of great importance, particularly at high speed – see page 99.

A3 FRONT

S3 REAR

TECHNICAL DATA

WEIGHTS (KG)

Normal payload	GVW		Unladen weight (with driver)		Payload ²⁾		Permissible front axle load	Permissible rear axle load	Permissible roof load ⁴⁾
	Petrol	Diesel	Petrol	Diesel	Petrol	Diesel ⁵⁾			
Van	2390	2460	1395	1465	995	995	1200	1300	100
High Roofed Van	2390	2460	1445	1515	945	945	1200	1300	-
Combi	2390	2460	1395 ¹⁾	1465 ¹⁾	995 ³⁾	995 ³⁾	1200	1300	100
High Roofed Combi	2390	2460	1445 ¹⁾	1515 ¹⁾	945 ³⁾	995 ³⁾	1200	1300	-
Caravelle, Combi L	2390	2460	1480 ¹⁾	1550 ¹⁾	910 ³⁾	910 ³⁾	1200	1300	100
Caravelle Carat	2340	-	1730 ¹⁾	-	610 ¹⁾	-	1200	1300	75
Caravelle GL	2390	2360	1510 ¹⁾	1580 ¹⁾	880	880	1200	1300	100
Ambulance	2390	2400	1680	1750	710	650	1200	1200	100
High roofed ambulance	2390	2400	1900	1950	490	430	1200	1200	-
Pick-up	2390	2460	1395	1465	995	995	1200	1300	-
Pick-up with large platform	2390	2460	1490	1560	900	900	1200	1300	-
Double Cab	2390	2460	1480	1550	940	940	1200	1300	75

Notes

■ Other model versions and optional extras – e.g. catalytic converter, air conditioner, sliding roof, towing bracket etc. and service installation of accessories increases the unladen weight and the payload has to be reduced by this amount.

■ The load must be stowed so that it cannot slide about or even fly forward when the brakes are applied.

■ When carrying heavy loads, the load should, in the interests of good handling, be placed, where possible, between the axles. The permissible axle and gross vehicle weights must not be exceeded on any account. Bear in mind also that heavy weights will alter the vehicle handling. Driving style and speed must therefore be adapted to suit.

1) Without driver

2) On vehicles with automatic gearbox the payload is reduced by about 40 kg.

3) On vehicles without seats the payload is increased by about 65 kg.

4) Use only racks supported in rain channel. Load evenly and do not exceed the GVW. Further details are given on page 62.

5) On vehicles with a tow bar the permissible payload is reduced by 15 kg.

	Permissible GVW	Unladen weight (with driver)		Payload ²⁾		Permissible front axle load	Permissible rear axle load	Permissible roof load ⁴⁾
		Petrol	Diesel	Petrol	Diesel ⁵⁾			
Higher payload								
Van	2600	1395	1465	1205	1135	1300	1400	100
High Roofed Van	2600	1445	1515	1155	1085	1300	1400	-
Combi	2600	1395 ¹⁾	1465 ¹⁾	1205 ³⁾	1135 ³⁾	1300	1400	100
High Roofed Van Combi	2600	1445 ¹⁾	1515 ¹⁾	1155 ³⁾	1085 ³⁾	1300	1400	-
Caravelle, Combi L	2600	1480 ¹⁾	1550 ¹⁾	1120 ³⁾	1090 ³⁾	1300	1400	100
Pick-up	2600	1395	1465	1205	1135	1300	1400	-
Pick-up with large platform	2600	1490	1560	1110	1040	1300	1400	-
Double Cab	2600	1450	1520	1150	1080	1300	1400	75
Reduced payload (800 kg)								
Van	2195/2265 ⁶⁾	1395	1465	800	800	1100	1200	100
Combi	2195/2265 ⁶⁾	1395 ¹⁾	1465 ¹⁾	800 ³⁾	800 ³⁾	1100	1200	100

Notes

■ Other model versions and optional extras – e.g. catalytic converter, air conditioner, sliding roof, towing bracket etc. and service installation of accessories increases the unladen weight and the payload has to be reduced by this amount.

■ The load must be stowed so that it cannot slide about or even fly forward when the brakes are applied.

■ When carrying heavy loads, the load should, in the interests of good handling, be placed, where possible, between the axles. The permissible axle and gross vehicle weights must not be exceeded on any account. Bear in mind also that heavy weights will alter the vehicle handling. Driving style and speed must therefore be adapted to suit.

1) Without driver

2) On vehicles with automatic gearbox the payload is reduced by about 40 kg.

3) On vehicles without seats the payload is increased by about 65 kg.

4) Use only racks supported in rain channel. Load evenly and do not exceed the GVW. For further details – see page 62.

5) On vehicles with Turbo Diesel engine the payload is reduced by about 15 kg.

6) Diesel/Turbo Diesel engine – 8

TECHNICAL DATA

WEIGHTS (syncro)

in kg	GWV	Unladen weight (with driver)	Payload ⁴⁾	Permissible front axle load	Permissible rear axle load	Permissible roof load ³⁾
Van	2500	1540	960	1300	1380	100
High Roofed Van	2500	1590	910	1300	1380	—
Combi	2500	1540 ¹⁾	960 ²⁾	1300	1380	100
High Roofed Combi	2500	1590 ¹⁾	910 ²⁾	1300	1380	—
Caravelle/Combi L	2500	1625 ¹⁾	875 ²⁾	1300	1380	100
Caravelle GL	2500	1655 ¹⁾	845	1300	1380	100
Ambulance	2500	1825	675	1300	1380	100
Pick-up	2500	1540	960	1300	1380	100
Pick-up with large platform	2500	1635	865	1300	1380	100
Double Cab	2500	1595	905	1300	1380	75

Notes

■ Other model versions and optional extras – e.g. catalytic converter, air conditioner, sliding roof, towing bracket etc. and service installation of accessories increases the unladen weight and the payload has to be reduced by this amount.

■ The load must be stowed so that it cannot slide about or even fly forward when the brakes are applied.

■ The payload must be reduced by 200 kg when towing a trailer (does not apply to vehicles with 16 inch wheels).

■ When carrying heavy loads, the load should, in the interests of good handling, be placed, where possible, between the axles. The permissible axle and gross vehicle weights must not be exceeded on any account. Bear in mind also that heavy weights will alter the vehicle handling. Driving style and speed must therefore be adapted to suit.

- 1) Without driver
- 2) On vehicles without seats the payload is increased by about 65 kg.
- 3) Use only racks supported in rain channel. Load evenly and do not exceed the GWV.
- 4) On vehicles with Turbo Diesel engine the payload is reduced by 15 kg.
On vehicles with 16 inch wheels the payload must be reduced by 50 kg.

www.vw-t25camper.info – a useful website for owners and enthusiasts of VW T25 / T3 / Vanagon Campervans

TRAILER WEIGHTS

See also "Trailer towing" on page 68	44 kW 4 speed	5 speed	57 kW 68 kW 70 kW 82 kW	Turbo Diesel	Diesel engine	syncro 57, 82 kW	64 kW	Turbo Diesel	70 kW
Permissible trailer weights									
Trailer with brakes, gradient up to 12 % kg	1500	1500	1500	1500	1200	2000	1500	1500	2000
with higher payload kg	1300	1300	1300	1300	1000	-	-	-	-
Special certificate ²⁾									
gradient up to 10 % kg	-	-	-	2000	-	2500 ¹⁾	-	2000	-
with higher payload kg	-	-	-	1800	-	-	-	-	-
gradient up to 12 % kg	1800	2000	2000	-	1400	-	-	-	-
with higher payload kg	1600	1800	1800	-	1200	-	-	-	-
Trailer without brakes kg	600	600	600	600	600	600	600	600	600
Permissible nose weight of trailer drawbar on the ball of towing									
bracket max. kg	75	75	75	75	75	75	75	75	75
Special certificate ²⁾ max. kg	100 ³⁾	100 ³⁾	100 ³⁾	100 ³⁾	100 ³⁾	100 ³⁾	100 ³⁾	100 ³⁾	100 ³⁾
..... min. kg	4 % of actual trailer weight, but not more than the maximum permitted								

- 1) Rear axle loading min. 1000 kg
- 2) V.A.G. Dealerships have the details
- 3) If the towing bracket is designed for this

TECHNICAL DATA

DIMENSIONS

in mm	Length	Width	Height		Ground clear- ance ¹⁾	Overhang		Wheel- base	Track		Turning circle in m
			with canopy	without canopy		front	rear		front	rear	
Van	4570	1845	1965	–	190	1160	950	2460	1583	1570	10.7
High Roofed Van	4570	1845	2365	–	190	1160	950	2460	1583	1570	10.7
Combi	4570	1845	1960	–	190	1160	950	2460	1583	1570	10.7
High Roofed Combi	4570	1845	2360	–	190	1160	950	2460	1583	1570	10.7
Caravelle CL, GL, Combi L,	4600	1845	1950	–	190	1175	965	2460	1583	1570	10.7
Caravelle Carat	4605	1845	1960	–	190	1180	965	2460	1603	1588	10.9
Ambulance	4570	1845	2215	–	190	1160	950	2460	1583	1570	10.7
Pick-up	4570	1870	1930	2235	190	1160	950	2460	1583	1570	10.7
Pick-up with large platform	4570	2000	1930	2235	190	1160	950	2460	1583	1570	10.7
Double Cab	4570	1870	1925	2230	190	1160	950	2460	1583	1570	10.7

¹⁾ at permissible GW.

When negotiating steep ramps, driving over poor surfaces, curbs etc., particularly with vehicles with a spoiler, gas containers and heater mounted underneath the floor, care must be taken not to "bottom" and thus cause damage to these fittings.
On vehicles with low-set running gear the ground clearance is reduced by about 30 mm.

DIMENSIONS (syncro with 14 inch wheels)

in mm	Length	Width	Height		Ground clearance ¹⁾		Overhang		Wheel base	Track		Turning circle in m	Wading Depth ²⁾
			without cover	with cover	front	rear	front	rear		front	rear		
Van	4570	1845	1990	—	215	193	1160	950	2455	1568	1560	10.9	350
High Roofed Van	4570	1845	2390	—	215	193	1160	950	2455	1568	1560	10.9	350
Combi	4570	1845	1990	—	215	193	1160	950	2455	1568	1560	10.9	350
High Roofed Combi	4570	1845	2390	—	215	193	1160	950	2455	1568	1560	10.9	350
Caravelle CL, GL, Combi L	4600	1845	1990	—	215	193	1175	965	2455	1568	1560	10.9	350
Ambulance	4570	1845	2245	—	215	193	1160	950	2455	1568	1560	10.9	350
Pick-up	4570	1870	1995	2265	215	193	1160	950	2455	1568	1560	10.9	350
Pick-up with large platform	4570	2000	1995	2265	215	193	1160	950	2455	1568	1560	10.9	350
Double Cab	4570	1870	1995	2265	215	193	1160	950	2455	1568	1560	10.9	350

- 1) at permissible GVW with 185 R 14 C tyres. With 205 R 14 tyres ground clearance is increased by 14 mm.
When negotiating steep ramps, driving over poor surfaces, curbs etc., particularly with vehicles with a spoiler, gas containers and heater mounted underneath the floor, care must be taken not to "bottom" and thus cause damage to these fittings.
- 2) The wading depth for vehicles with turbocharged Diesel engine is 200 mm.

TECHNICAL DATA

DIMENSIONS (syncro with 16 inch wheels)

in mm	Length	Width	Height ¹⁾		Ground clearance ¹⁾		Overhang		Wheel base	Track		Turning circle in m	Wading Depth ²⁾
			without cover	with cover	front	rear	front	rear		front	rear		
Van High Roofed	4570	1845	2020	–	246	218	1160	925	2480	1597	1590	11.3	500
Van Combi High Roofed	4570	1845	2420	–	246	218	1160	925	2480	1597	1590	11.3	500
Van Combi	4570	1845	2020	–	246	218	1160	925	2480	1597	1590	11.3	500
Van Combi Caravelle CL, GL,	4570	1845	2420	–	246	218	1160	925	2480	1597	1590	11.3	500
Van Combi L	4600	1845	2020	–	246	218	1175	925	2480	1597	1590	11.3	500
Van Ambulance	4570	1845	2275	–	246	218	1160	925	2480	1597	1590	11.3	500
Van Pick-up	4570	1870	2025	2295	246	218	1160	925	2480	1597	1590	11.3	500
Van Pick-up with large platform	4570	2000	2025	2295	246	218	1160	925	2480	1597	1590	11.3	500
Van Double Cab	4570	1870	2025	2295	246	218	1160	925	2480	1597	1590	11.3	500

1) At permissible GVW with 195 R 16 tyres. With 205 R 16 tyres the figure is increased by 8 mm.

When negotiating steep ramps, driving over poor surfaces, curbs etc., particularly with vehicles with a spoiler, gas containers and heater mounted underneath the floor, care must be taken not to "bottom" and thus cause damage to these fittings.

2) On vehicles with turbo Diesel engine the wading depth is 390.

CAPACITIES

Fuel tank	approx. 60 litres (13 galls)
Fuel tank syncro	approx. 70 litres (15.3 galls)
Windscreen washer	approx. 3.5 litres
With headlight washer	approx. 6.5 litres
Rear window washer	approx. 1.0 litre

Petrol engines

Cooling system (with heater)	approx. 17.5 litres
Engine oil – with filter change	approx. 4.5 litres
Engine oil – without filter change	approx. 4.0 litres
Difference between Max.-Min. marks on dipstick	1.0 litre

Diesel engines

Cooling system (with heater)	approx. 16 litres
Engine oil – with filter change	approx. 4.5 litres
Engine oil – without filter change	approx. 4.0 litres
Difference between Max.-Min. marks on dipstick	approx. 1.0 litre

TECHNICAL DATA

VEHICLE IDENTIFICATION DATA



The identification plate

is on the right hand door pillar between the hinges.

Vehicles for export to certain countries have no identification plate.



Vehicle identification number (Chassis number)

is stamped under the vehicle on the front cross member.

1	SORT. NR.	
2	FAHRZEUG-IDENT-NR. VEHICLE IDENT. NO.	
3	TYP./TYPE	
4		
5	MOTORKB. / GETR. KB. ENG. CODE / TRANS. CODE	
6	LACKNR. / INNENAUSST. PAINT NO. / INTERIOR	
7	M - AUSST. / OPTIONS	

B 17- 18

The vehicle data sticker

is located on the cross member on the left under the dash. The sticker contains the following data:

1. Production control number
2. Vehicle identification number
3. Model code number
4. Model explanation
5. Engine and gearbox code letters
6. Paint number/interior trim code
7. Optional extra numbers

The vehicle data 2-7 is also given in the Service Schedule.



Engine number

On the petrol engines the number is stamped on the block behind the vee belt pulley. It can be seen when the maintenance flap is opened.

On the Diesel engine the number is stamped in the block near the injection pump.

ALPHABETICAL INDEX

	Page		Page		Page
Accessories,		Care of body	79	Cooling system	91
parts and modifications	105	Care of vehicle	79	Cover, engine	84
Activated charcoal filter	126	Canopy	62	Cross country gear	27
Additional heat exchanger	50	Capacities	145	Cruise control system	46
Adjusting jets	98	Catalytic converter	126	Cubic capacity	128
Air conditioner	56	Cavity preservation	82	Curtains	61
Alloy wheels	81	Centre seat	19		
Anti-freeze	91	Central locking	8	Defrosting windows	49
Anti-knock petrol	76	Cetane number	77	Diesel fuel	77
Anti-locking brake system (ABS)	26, 37	Changing bulbs	112	Differential locks	28
Arduous operating conditions	103	Changing wheels	109	Digital clock	40
Ashtray	60	Changing wiper blades	98	Dimensions	142
ATF	89	Chassis number	146	Dipstick	87
Automatic gearbox	32	Child's seat	13	– engine	87
Automatic seat belts	15	Child-proof lock	9	– automatic gearbox	89
Auxiliary heater	51, 54	Cigarette lighter	60	Dip switch	45
Axle loads	138	Cleaning and preserving engine compartment	82	Do-it-yourself	106
		Climbing ability	133	Doors	9
Battery acid level	95	Clock	40	Drawbar weight	141
Battery/acid	95	Cold starting aid	4, 35	Driver's seat	18
Brake fluid	94	Compression ratio	128	Driving abroad	103
Brake servo	26	Consumption figures	129	Driving economically	65
Brake system	25	Coolant additive	91	Driving environment-consciously	65
Brake warning light	37	Coolant level	92	Driving safely	64
Bulb changing	112	Coolant temperature gauge	41	Driving tips	63
				Dropsides	62

ALPHABETICAL INDEX

	Page		Page		Page
Electric window lifters	11	– Brake fluid	94	Gear lever	27
Electric seat adjustment	22	– Care of vehicle	79	Gear oil	89
Emergency light system	43	– Coolant	91	Glove box	62
Emergency starting	118	– Fuel	76	Glow plugs	35, 38
Emission control system	126	– Engine oil	85		
Engine		– Tyres	99	Handbrake	26
– code letters	146	– Tyre pressures	99, 137	Headlights	43, 112
– compartment	84	– Filling the tank	75	– masking	116
– data	129	– Driving environment consciously	65	– adjusting	116
– number	147	– Washing vehicle	79	Headlight flasher	45
– oil	85	– Maintenance	83	Head restraints	17
– oil additives	88			Heated rear window	43
– oil capacity	145	Filling tank	75	Heating	48
– oil consumption	87	First Aid Kit	106	High beam	39, 45
– oil level	87	Floor mats	25	Holiday driving	103
– starting/stopping	34, 36	Fog lights	44, 114	Horn	4
Engine compartment flap	84	Four-wheel drive	70		
Environment		Front spoiler	26, 101	Identification plate	146
– Driving with low pollutant and noise levels	65	Fuel	76	Ignition switch	33
– Emission control system	126	– additives	76	Inspection intervals	83
– Activated charcoal filter	127	– consumption	129	Instrument lighting	43
– Old oil	88	– filter	104	Instrument panel	4
– Old tyres	101	– filter preheating	77	Instruments	40
– Battery	96	– gauge	42	Interior lights	59
– Petrol vapour accumulator	127	– saving	65	Interior mirror	12
– Unleaded petrol	76	Fuses	110		

ALPHABETICAL INDEX

	Page		Page		Page
Jack	106	Number plate lighting	115	Radiator fan	90
Jacking points	109	Octane number	76	Radio	5, 11
Kick-down	31	Oil additives	88	Reading lights	59, 110
Keys	7	Oil change intervals	88	Rear fog light	44
Lambda probe	126	Oil consumption	66, 87	Rear seat	21
Lamps, warning	6, 37	Oil dipstick	87, 89	Rear view mirror	12
Lap belts	16	Oils	85	Rear window/heating	43
Lifting vehicle	122	Oil specifications	85	Rear wiper and washer	47
Lighting	43	Outside mirrors	12	Reclining seat	23
Lighting switch	43	Output	128	Rev counter	41
Load surface	24	Paint number	146	Reverse gear	27
Load surface, increasing size of	24	Paint care	79	Reversing lights	27
Locks	9	Payload	139	Roof load	131
Lubricants	85	Parking	32, 126	Roof rack	62
Luggage compartment	24	Parking lights	45, 113	Running in	63
Luggage compartment cover	24	Parking lock	31	Safety switch	53
Maintenance	83	Pedals	25	Seat adjustment	18
Maximum engine speed	63	Petrol	76	Seat belts	13
Maximum road speed	132	Petrol consumption	129	Seats	18
Make-up mirror	60	Petrol additives	76	Seat heating	18, 44
Mileage recorder	40	Performance	132	Selector lever	31
Mirrors	12	Power assisted steering	89	Side lights	45, 113
M+S tyres	102	Power transfer	124	Sliding door	9
				Sliding roof	58
				Sliding windows	11

ALPHABETICAL INDEX

	Page		Page		Page
Snow chains	102	Taillights	114	Vehicle care	79
Socket	60	Tank cap	75	Vehicle data sticker	146
Spare wheel	107, 108	Tank capacity	145	Vehicle identification data	146
Spark plugs	134	Technical data	128	Ventilation	48
Speedometer	40	Technical description	123	Vent wings	11
Spoiler	26, 101	Tools	106	Viscosity grades	85
Starting engine	34	Towing	32, 120	Viscous coupling	70
Starting aid cables	118	Tow starting	32, 120		
Steering lock/ignition switch	30	Trailer towing	67	Warning lamps	6, 37
Steel sliding roof	58	Trailer weights	141	Warning triangle	106
Stopping engine	36	Travelling abroad	103	Washing vehicle	79
Sun roof	58	Tread depth	100	Washer jets, adjusting	97
Sun visors	60	Trip recorder	40	Water auxiliary heater	51, 54
Switches	43	Trolley jack	122	Weights	138
Swivelling seats	19	Turn signals	45, 114	Wheels, imbalance	99
Synco		Turn signal lever	45	Wheels	99, 136
– towing	121	Tyres		Wheel changing	100, 109
– differential locks	28	– inflation pressures	99, 137	Windows	11
– driving with four-wheel drive	70	– running in	99	Window deicing	80
– snow chains	71, 102	– wear	100	– defrosting	49
– technical description	123	– condition	99, 100	Windscreen washer system	47, 97
– technical data	128			Windscreen wipers	47
Table	61	Undercoating	82	Winter driving	104
Tachograph	42	Unleaded petrol	76	Wiper blades	98
Tailgate	10	Vee belts	135	Wipe/wash system	47
				Winter tyres	102

The factory is working continuously on the development of all models. We trust, therefore, that you will appreciate that we must reserve the right to alter, without notice, any part of the vehicle or equipment. No legal commitment is thus implied by the data, illustrations or descriptions in this manual.

© 1990 VOLKSWAGEN AG

May not be reproduced or translated in whole or in part without the written consent of VOLKSWAGEN AG. All rights reserved. Specifications subject to alteration without notice.

Printed in Germany

How you can help the environment

The fuel consumption of your Volkswagen Transporter/Caravelle – and thereby the pollutant content in the exhaust gas – are also determined by the way you drive.

Noise and wear are also influenced by the way the car is used.

This Instruction Manual explains how to drive your Volkswagen Transporter/Caravelle in a way that is compatible to the environment – and save money at the same time. Just turn to heading “Environment” in the alphabetical index.

Please do your bit – for the sake of the environment